

Air Force Institute of Technology

AFIT Scholar

Theses and Dissertations

Student Graduate Works

3-2002

A Life Cycle Cost Analysis of the Proposed Replacement of Pope Air Force Base's C-130E Fleet Using a Fleet Replacement Model

Lance R. French

Follow this and additional works at: <https://scholar.afit.edu/etd>



Part of the [Aviation Commons](#), and the [Finance and Financial Management Commons](#)

Recommended Citation

French, Lance R., "A Life Cycle Cost Analysis of the Proposed Replacement of Pope Air Force Base's C-130E Fleet Using a Fleet Replacement Model" (2002). *Theses and Dissertations*. 4390.
<https://scholar.afit.edu/etd/4390>

This Thesis is brought to you for free and open access by the Student Graduate Works at AFIT Scholar. It has been accepted for inclusion in Theses and Dissertations by an authorized administrator of AFIT Scholar. For more information, please contact richard.mansfield@afit.edu.



A LIFE CYCLE COST ANALYSIS OF THE PROPOSED
REPLACEMENT OF POPE AIR FORCE BASE'S C-130E
FLEET USING A FLEET REPLACEMENT MODEL

THESIS

Lance R. French, Captain, USAF

AFIT/GAQ/ENS/02-01

**DEPARTMENT OF THE AIR FORCE
AIR UNIVERSITY**

AIR FORCE INSTITUTE OF TECHNOLOGY

Wright-Patterson Air Force Base, Ohio

APPROVED FOR PUBLIC RELEASE; DISTRIBUTION UNLIMITED.

Report Documentation Page

Report Date 11 Mar 02	Report Type Final	Dates Covered (from... to) Oct 2000 - Mar 2002
Title and Subtitle A Life Cycle Cost Analysis of the Proposed Replacement of Pope Air Force Base's C-130-E Using a Fleet Replacement Model	Contract Number	
	Grant Number	
	Program Element Number	
Author(s) Capt Lance R. French, USAF	Project Number	
	Task Number	
	Work Unit Number	
Performing Organization Name(s) and Address(es) Air Force Institute of Technology Graduate School of Engineering and Management (AFIT/EN) 2950 P Street, Bldg 640 WPAFB, OH 45433-7765	Performing Organization Report Number AFIT/GAQ/ENS/02-01	
Sponsoring/Monitoring Agency Name(s) and Address(es) 43 OG/CDM Attn: Lt Col Michael Privette Pope AFB, SC	Sponsor/Monitor's Acronym(s)	
	Sponsor/Monitor's Report Number(s)	
Distribution/Availability Statement Approved for public release, distribution unlimited		
Supplementary Notes The original document contains color images.		

Abstract

The 43rd Airlift Wing at Pope AFB, NC, possesses 33 E-model C-130 aircraft. The airplanes range in age from 30-36 years old. The C-130Es at Pope AFB comprise two-thirds of the Air Force C-130s modified with the All-Weather Aerial Delivery System (AWADS). Current plans call for replacing Popes aging fleet of tactical airlifters with new C-130J model planes in FY11. However, given the age of Popes fleet, a lack of spare parts, and structural problems, maintenance costs are rising at an exponential rate. Because of this, there may be a more cost-effective replacement schedule to ensure Popes ability to generate mission-ready airframes when needed. There are two replacement alternatives proposed in this research. The first is to calls for replacing the C-130Es with C-130Js now. The second option is upgrade the C-130Es to C-130Xs and replace them in 10 years with the C-130J. The results indicate that the least cost solution is to upgrade Popes fleet of C-130Es to C-130Xs now. However, after conducting sensitivity analyses on the input parameters, the research shows the replace now option becomes the least cost solution when any one of the following occur: the C-130J O&S costs decrease by 15 percent below the estimated values, the service life of the C-130X drops below 6 years, or the C-130J acquisition costs decrease by 35 percent. In addition, this research looks at the budgetary consequences of each option.

Subject Terms

Life Cycle Costs, Fleet Replacement Model, Repair and Replacement Decisions

Report Classification

unclassified

Classification of this page

unclassified

Classification of Abstract

unclassified

Limitation of Abstract

UU

Number of Pages

80

The views expressed in this thesis are those of the author and do not reflect the official policy or position of the United States Air Force, Department of Defense, or the U.S. Government.

AFIT/GAQ/ENS/02-01

A LIFE CYCLE COST ANALYSIS OF THE PROPOSED
REPLACEMENT OF POPE AIR FORCE BASE'S C-130E
FLEET USING A FLEET REPLACEMENT MODEL

THESIS

Presented to the Faculty

Department of Systems and Engineering Management

Graduate School of Engineering and Management

Air Force Institute of Technology

Air University

Air Education and Training Command

In Partial Fulfillment of the Requirements for the
Degree of Master of Science in Acquisition Management

Lance R. French, BA

Captain, USAF

March 2002

APPROVED FOR PUBLIC RELEASE; DISTRIBUTION UNLIMITED

A LIFE CYCLE COST ANALYSIS OF THE PROPOSED
REPLACEMENT OF POPE AIR FORCE BASE'S C-130E
FLEET USING A FLEET REPLACEMENT MODEL

Lance R. French, BA
Captain, USAF

Approved:

//signed//

Dr. William A. Cunningham (Chairman)

date

//signed//

William K. Stockman, Lt Col, USAF (Member)

date

//signed//

Stephen M. Swartz, Lt Col (Sel), USAF (Member)

date

Acknowledgements

I would like to express my sincere appreciation to my faculty advisor, Dr. William Cunningham, for his guidance and support throughout the course of this thesis effort. The insight and experience was certainly appreciated. I would also like to thank my readers, Lt. Col. William Stockman and Lt. Col. Stephen Swartz. The information provided by Lt. Col. Stockman concerning the C-130J acquisition program was extremely helpful.

I am also indebted to Mr. Ed Pratt and Mr. John McDonald from Warner-Robins ALC for the tremendous amount of maintenance cost data they provided. In addition, I would like to thank Capt. Jeremy Anfinson of the Air Mobility SPO at Wright-Patterson AFB for his help with the C-130J acquisition cost data.

And, finally, I need to give thanks to Ms. Janice Farr. Her help with editing and formatting enabled me to bring this research together into a neat and coherent product.

Table of Contents

	Page
Acknowledgements	iv
List of Figures	vii
List of Tables	viii
Abstract	ix
I. Introduction.....	1
General Issue	1
Alternate Airframe Systems	3
Research Objectives.....	6
Research Approach.....	6
Research Criteria and Assumptions	7
Related Definitions	8
II. Literature Review	10
Introduction.....	10
The Aging Aircraft Problem.....	10
Fleet Replacement Models	15
Life Cycle Cost Overview	19
Summary.....	24
III. Methodology.....	25
Introduction.....	25
Cost Analysis and Assumptions	25
Cost Elements Definitions	27
Description of Model Pathways.....	30
Description of Replacement Model Factors	31
Summary.....	34
IV. Analysis	36
Minimum Total Cost Approach.....	36
Model Results	36
Sensitivity Analysis	43
Budgetary Consequences	46
Analysis Summary.....	48

V. Findings and Conclusions	49
Evaluation of Alternatives	49
Most Probable Scenario Solution	50
Research Recommendations	52
Final Comments	52
Appendix A. C-130J Cost Data	54
Appendix B. C-130E/X Cost Data	58
Appendix C. Data for C-130J O&S Cost Decrease Effects	62
Appendix D. Data for C-130J Acquisition Cost Increase Effects	63
Appendix E. Data for C-130X Service Life Variation Effects	64
Appendix F. Network Flow Model.....	65
Bibliography.....	66
Vita.....	69

List of Figures

Figure	Page
1. Research Design.....	7
2. Age of U.S. Air Force Aircraft	11
3. Bathtub Failure Rate Curve	12
4. Two-Cycle Replacement Model	16
5. Two-Cycle Research Design Model	18
6. DOD 5000 Acquisition Model.....	20
7. Distribution of Life Cycle Costs	21
8. Research Model.....	30
9. Effects of C-130J O&S Cost Decrease	44
10. Effects of Variation in C-130J O&S Annual Increase	44
11. Effects of C-130J Acquisition Cost Decrease.....	45
12. Effects of Increased Service Life of C-130X.....	46
13. Procurement Funding Requirements.....	47
14. O&M Budget Requirements	47

List of Tables

Table	Page
1. Comparison of Systems on C-130E Modernization Alternatives	5
2. Comparison of Performance Parameters	5
3. MCR Differences Between the Airframes	26
4. C-130J Acquisition Discount	27
5. Replacement Model Results Screen	32
6. Arc Costs	34
7. Model Input Cost Parameters	36
8. Model Results for Lot 1	37
9. Model Results for Lot 2	38
10. Model Results for Lot 3	39
11. Lot 1 Results with Insufficient Quantity Penalty	41
12. Results with Early Ordering Discount	42
13. Results with Quantity Discount (Upgrade/Replace)	42
14. Results with Quantity Discount (Replace)	42
15. Analysis Summary	49
16. Most Probable Scenario Results	51

Abstract

The 43rd Airlift Wing at Pope AFB, NC, possesses 33 E-model C-130 aircraft. The airplanes range in age from 30-36 years old. The C-130Es at Pope AFB comprise two-thirds of the Air Force C-130s modified with the All-Weather Aerial Delivery System (AWADS). Current plans call for replacing Pope's aging fleet of tactical airlifters with new C-130J model planes in FY11. However, given the age of Pope's fleet, a lack of spare parts, and structural problems, maintenance costs are rising at an exponential rate. Because of this, there may be a more cost-effective replacement schedule to ensure Pope's ability to generate mission-ready airframes when needed.

There are two replacement alternatives proposed in this research. The first is to call for replacing the C-130Es with C-130Js now. The second option is upgrade the C-130Es to C-130Xs and replace them in 10 years with the C-130J.

The results indicate that the least cost solution is to upgrade Pope's fleet of C-130Es to C-130Xs now. However, after conducting sensitivity analyses on the input parameters, the research shows the replace now option becomes the least cost solution when any one of the following occur: the C-130J O&S costs decrease by 15 percent below the estimated values, the service life of the C-130X drops below 6 years, or the C-130J acquisition costs decrease by 35 percent. In addition, this research looks at the budgetary consequences of each option.

A LIFE CYCLE COST ANALYSIS OF THE PROPOSED
REPLACEMENT OF POPE AIR FORCE BASE'S C-130E
FLEET USING A FLEET REPLACEMENT MODEL

I. Introduction

General Issue

There comes a time in the service life of every system when a decision must be made on whether to keep repairing and maintaining it or to replace it. This is not an easy decision as acquisition costs for new systems can dwarf the yearly maintenance costs of the old system. Because of this, the replacement decision is pushed further into the future. This problem has arisen at one air force base in particular.

The 43rd Airlift Wing at Pope Air Force Base (PAFB) possesses 33 C-130E aircraft modified with the All-Weather Aerial Delivery System (AWADS). The AWADS system gives the ability to airdrop in otherwise prohibitive conditions, such as, night drops, poor weather visibility and high altitude. These 33 aircraft represent two-thirds of the Air Force's C-130s capable to do AWADS flights.

Commanders and maintenance personnel are concerned that the aircraft have reached the end of their service lives. The C-130Es at Pope range in age from 30-36 years old. Although a decision has been made to replace these aircraft with the new C-130J

model, the replacement will not be complete until fiscal year 2011. Further, history has shown that acquisition programs rarely occur exactly when forecasted. There is also concern that the replacement schedule was not based on studies to determine whether Pope's current inventory of C-130Es are sustainable to 2011.

In addition, the decision was not based on a cost analysis of repair costs versus replacement costs to determine the least cost replacement schedule. The replacement schedule instead appears to be based on fiscal and political influences.

The C-130J program is closely watched by Congress as it affects other programs like the F-22 Raptor. Lockheed Martin, the manufacturer of the C-130J and F-22, has claimed that if the Air Force does not maintain a steady acquisition of C-130Js, the costs of the F-22 will increase as a result of increased overhead costs being applied to the fighter program. This has resulted in increased attention by the Pentagon and Congress into C-130J acquisitions.

Aircraft acquisitions are also closely tied to fiscal restraints. Typically, an acquisition decision is not made to achieve the lowest possible cost, but rather, when the funds are available. In fact, the Pilot Program Consulting Group (PPCG) appointed by the Deputy Under Secretary of Defense, Acquisition Reform, noted that C-130J funding is very unstable. While funding is made available for aircraft acquisitions, the program office rarely receives funding for aircraft support. In fact, support funding for 1998-2001 was pulled to pay for other programs (PPCG, 1997:n.pag.).

This research will attempt to conduct an in-depth cost analysis to determine the optimal replacement schedule for the 33 aircraft at Pope AFB.

Alternate Airframe Systems

C-130E/C-130X. The C-130 aircraft provides the intratheater portion of the airlift mission and is one of the most versatile aircraft in the world. It is capable of operating from rough, dirt strips and is the prime transport for dropping paratroops and equipment into hostile territory. The C-130E was introduced in 1961 as an extended-range development of the C-130B. The “E” model was produced with two under wing fuel tanks for increased range and endurance. Production of the “E” model ended in the early 1970s (Morris, 1989:22).

Instead of replacing the C-130E with the C-130J there is the option to upgrade the airframes to the C-130X. The ‘X’ combines the Avionics Modernization Program (AMP) configuration with Service Life Extension Program (SLEP) improvements.

The AMP and SLEP upgrade includes an improved set of avionics, engines, radar and auxiliary power units. In addition to these improvements, SLEP ensures structural components, such as center wing box, fuselage, and outer wing are replaced as certain flying hour milestones are reached. Because the C-130X creates a common baseline for the thirteen different variants of the C-130 currently being flown, the Air Force recognizes this as a major fleet improvement. General Charles Robertson, Commander in Chief of U.S. Transportation Command, describes the effort as “...a modernized C-130 that’s going to rise like the Phoenix from our current mixes of ‘Es,’ ‘H1s,’ ‘H2s,’ and ‘H3s.’” (AFN, 1999).

Thus, an advantage of the ‘X’ option is that many different C-130 variants are transformed into one. As Major Haven noted in his thesis on the C-130, “This difference in configuration impacts the operational mission. A crewman qualified in the C-130E is not automatically qualified to fly the C-130H3 because they are considered completely different weapons systems” (Haven, 1998:15).

C-130J. The C-130J is the newest Hercules built by Lockheed Martin Aeronautics Company. According to the manufacturer the “J” model is a dramatic improvement to the “E” model. The C-130J has a 21% increase in maximum cruising speed, 50% reduction in climb time, 40% higher cruising altitude, and 40% increase in range. However, the cargo capacity will remain the same as the “E” model (Lockheed Martin, 2001).

Another dramatic difference between the two airframes is the size of the flight crew. Although neither the “X” nor the “J” model require a navigator, the “J” model also eliminates the need for a flight engineer.

In addition to these physical improvements of the airframe, Lockheed claims the C-130J offers reduced maintenance manpower requirements, and lower operating and support costs, thus resulting in overall lower life-cycle costs.

The following tables are adapted from the C-130 Remanufacturing Study conducted by the Institute for Defense Analyses (IDA, 1998:ES3-ES4). Table 1 depicts the system comparison between the two airframe alternatives.

Table 1. Comparison of Systems on C-130E Modernization Alternatives

System	“X”	“J”
Electrical and Environmental system	v	v
Common Auxiliary Power Unit (APU)	v	v
Night Vision System	v	v
Enhanced Ground Collision Avoidance System (GCAS)	v	v
Global Positioning System (GPS) & Traffic Collision Avoidance System (TCAS)	v	v
Global Air Traffic Management (GATM) Radios	v	v
Moderate Avionics and Autopilot Upgrade	v	
Engine Upgrade to T56-A-15	v	
New AE-2100 Engine with Full Authority Digital Control (FADEC)		v
New Avionics and Integration		v
New Cargo Handling System		v

Table 2 compares the performance parameters of the two airframes.

Table 2. Comparison of Performance Parameters

Performance Parameter	C-130X	C-130J
Takeoff Distance (ft)	3,500	3,200
Time to Reach Safe Altitude (Roll to 20,000 ft altitude) (min)	20	12.5
Range with 25,000lb Payload (nm)	3,050	3,700 (3,400 without tanks)
Mission Capable Rate	81	85.4
Average Crew Size	4.1	3

The C-130X shows a flight crew of 4.1 because although the aircraft does not require a navigator, the Air Force insists that a navigator be present for 10 percent of the flights.

Research Objectives

The objective of this research is to find the most cost efficient solution to Pope's aging C-130E fleet. Possible solutions are to speed up the replacement acquisition of the C-130J, push the replacement further out, or keep the current replacement schedule.

This requires a comparison of the costs of the two alternatives: buying a C-130J or keeping the C-130E and upgrading it to the C-130X. The life cycle costs of both airframes will be compared. This will include acquisition costs, operations and support costs, and, for the C-130E, service life extension program (SLEP) costs.

Research Approach

The objective of this research is to find the most cost efficient solution to Pope's aging C-130E fleet. To meet this objective a cost comparison of possible alternatives will be accomplished.

The decision will be based on an equipment replacement model. Instead of making a decision for each individual airframe, Pope's fleet will be divided into 3 batches. Each batch will contain eleven aircraft.

The reason for using batches in lieu of individual aircraft is to simplify the research approach and mirror the way the aircraft would be purchased or upgraded in reality. The Air Force usually does not purchase aircraft one at a time, but in batches. The same is true for upgrade programs. The figure below represents a simplified version of the research design. A more thorough examination will be made in Chapter 3.

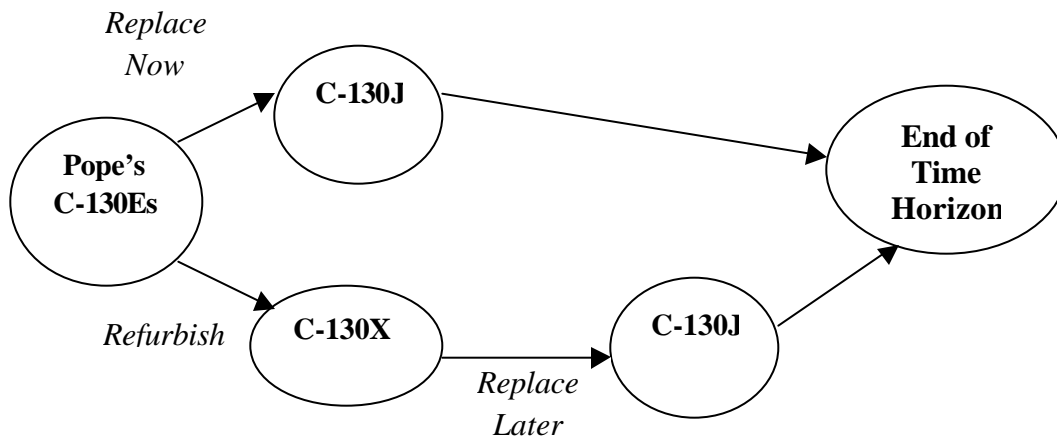

Figure 1. Research Design

At time zero a decision for each group will be made, replace the C-130Es with the “J” model or retain and refurbish the “E” models through the C-130X modernization program. If the decision is to replace, then the airframes remain C-130Js to the end of the time horizon. However, if the group is refurbished to C-130Xs, the replacement will still be made but at ‘*t*’ years later. The maximum value for ‘*t*’ years has been determined by program office personnel. It establishes how long the refurbished group (C-130X) can fly depending on the age at refurbishment. The maximum value for ‘*t*’ is 10 years.

Research Criteria and Assumptions

The life cycle costs of both airframes will be compared. This will include acquisition costs, and operations and support costs, and for the C-130E – AMP and SLEP costs.

In order to conduct a comparison among the replacement alternatives, a time horizon must be chosen. For this study a 40-year time horizon was chosen, FY2003

through FY2043. The rationale behind this is if the alternative of buying the C-130Js today was chosen, 40 years would approximate the airframes' service life.

The Air Force has decided the replacement for the C-130E is the C-130J. Even with extensive upgrades and component replacement, the C-130Es will need to be replaced. Therefore, this study assumes that the C-130Es will be replaced, however, this research focuses on the 'when' and 'how' of the replacement decision based on the alternatives addresses above.

This research provides a cost analysis for determining when to replace the C-130E with the C-130J based on cost. This research does not directly take into account the increased performance parameters of the new airframe. It is assumed that the C-130J's increased cruising speed and range and smaller crew size are included in the aircraft's O&S costs.

There is one performance parameter that will be taken into account directly. This study will analyze the effects of the increased mission capable rate (MCR) of the C-130J over the C-130X. Chapter 3 will explain how the MCR of the airframes will be incorporated into the replacement model.

Related Definitions

Avionics Modernization Program (AMP) – Program designed to install a new common set of avionics for many C-130 airframe variants.

Fiscal Year (FY) – A twelve-month period for which an organization plans the use of its funds. For the U.S. Government, 1 Oct – 30 Sep.

Life Cycle Costs – All costs incurred by a system throughout its service life to include acquisition, O&S, and disposal.

Operation and Support (O&S) Costs – Those costs required to keep a system operational to include maintenance, petroleum, oil, and lubricant (POL), and personnel and training.

Service Life – The expected duration of usable service of a system.

Service Life Extension Program (SLEP) – This is a program designed to increase the service life of a system by replacing structural components.

II. Literature Review

Introduction

In order to adequately provide options for Pope AFB's aging fleet, three main areas of study must be reviewed. They are aging aircraft problems and issues, fleet replacement models, and system life cycle costs.

This chapter begins with a discussion on aircraft aging problems. The costs and risks associated with older airframes are addressed as well as potential solutions.

The review then looks at some fleet replacement models that are currently used by industry to determine when it is appropriate to replace capital equipment. The Air Force currently does not have a model to determine when the costs of operating and maintaining an aged aircraft have become so high as to warrant replacement.

Finally, a review of relevant literature pertaining to life cycle costs. This includes a detailed analysis of all the elements that make up a system's life cycle cost.

The Aging Aircraft Problem

A major problem faced by the air force today is how to deal with the service's aging aircraft. The U.S. Air Force's current cargo aircraft inventory contains some airframes that became operational 25 to 30 years ago. As these aircraft get older they became very costly to maintain. As noted by Deputy Chief of Staff (Installations and Logistics) Lt. Gen. William Hallin, "Reducing costs becomes even harder with an aging fleet, whose increasing O&S costs are driven by parts obsolescence, fatigue, and airframe and engine challenges" (Hallin, 1998:1).

In 1997 the U.S. Air Force requested that the National Research Council conduct a study on the aging aircraft problem and provide recommendations for potential solutions. Figure 2 shows the average age of aircraft in the U.S. Air Force.

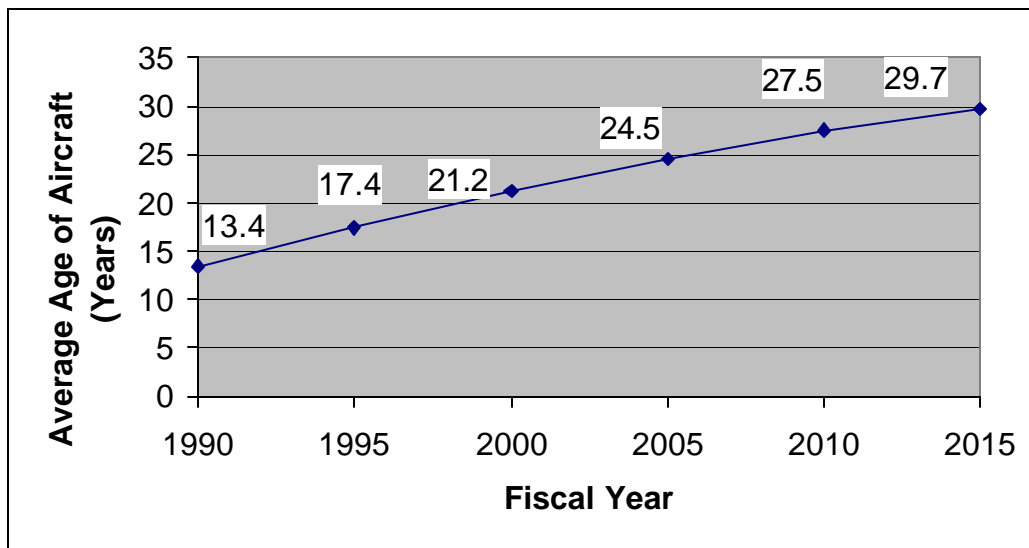

Source: Adapted from National Research Council in Aging of U.S. Air Force Aircraft (1997).

Figure 2. Age of U.S. Air Force Aircraft

The research council noted that all of the older aircraft (25+ years old) have encountered aging problems such as fatigue cracking, stress corrosion cracking, and wear. These problems not only contribute to increased maintenance costs but also impact mission readiness and safety of flight issues. The National Research Council stated in their study:

The economic burden associated with the inspection and repair of fatigue cracks can be expected to increase with age until the task of maintaining aircraft safety could become so overwhelming and the aircraft availability so poor that the continued operation of the aircraft is no longer viable. In addition, corrosion detection, repair, and component replacement can add significantly to or, in some cases, dominate the total structured maintenance burden. (NCR, 1997:2)

Operating costs are generally believed to follow a bathtub curve. That is, the costs are high at the beginning of the system's service life, decrease to a relatively stable amount for some time. Then as the system ages, the cost to maintain it begins to rise again.

The reason the costs follow this curve is that the components within the system experience failures in accordance with a hazard rate function (Ebeling, 1997:31). The hazard rate function is shaped just like a cost bathtub curve, Figure 3.

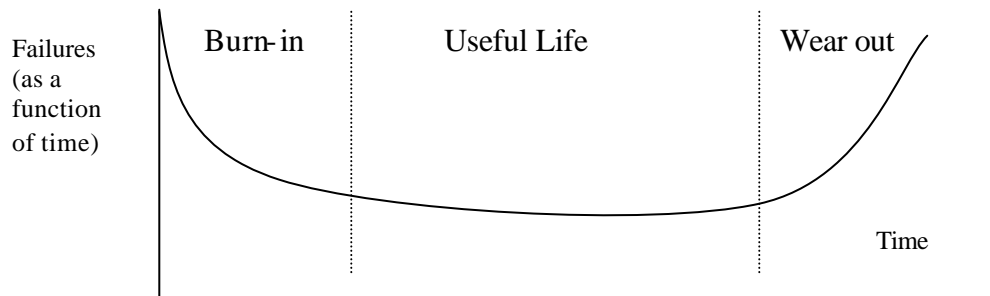

Figure 3. Bathtub Failure Rate Curve

As these components age and begin to failure more rapidly the cost to maintain the entire system will rise. Because of the limited funding for maintenance and support, the operational availability of the aircraft begin to decrease.

Replacement of a system is considered to be a regeneration point of the whole life cycle, where the hazard failure rate function and operating cost function start again at the origin. Upgrade of a system, however, results in the general characteristics of the two functions to be retained, but the curves are shifted downward (Kabir, 1996:49).

A study conducted by the former Air Force Logistics Command (now Air Force Materiel Command) concluded that not only do modifications and upgrades extend the service life of airframes, but also not upgrading actually results in a reduction of the original service life.

It is logical to consider that modifications performed on an aircraft will extend its life. Some modifications are performed for that specific purpose as the state-of-the-art is improved. Other modifications are accomplished to improve the aircraft capability and often provide an advantage of extending the life of the particular part modified. The converse is also true, that when modifications are withheld, the life of the aircraft may be reduced (Foster and Hunsaker, 1983:vii).

The effects of age on aircraft were specifically addressed for the C-130 beginning in 1998. After a series of flight mishaps involving older C-130s, the Secretary of the Air Force tasked the department to conduct a Broad Area Review (BAR) of the entire C-130 fleet. In addition, the Congress requested that the General Accounting Office (GAO) also accomplish a study of the C-130.

The reports stated that although the Air Force has requirements for C-130Js to replace the oldest C-130s, a large scale C-130J program was not needed as most of the C-130Es still had many years of service life remaining and could be extended further with AMP and SLEP modifications. In fact, the report went on to say that most of the C-130J acquisitions were congressionally directed buys (GAO Report, 1998 and BAR Report, 1998).

An important factor in determining age related problems, is knowing where the system is in terms of its useful life. A system has a number of lives, including service life, technological life, and economic life (Dolce, 2000:1-2).

Service life is the amount of time a system is capable of operating in a manner to which it was built. This life may be extended with extensive component replacement and preventative maintenance. However, once the system reaches its absolute service life (modifications can no longer extend it) the system, specifically an aircraft, becomes dangerous to operate and must be retired.

Systems also have a technological life. This refers to the productivity decline of the system as compared to available replacements. The original system may still be capable of operating, that is, it still has service life remaining. However, there are other systems that surpass the performance of the original system, thus making the original technologically obsolete.

The final life of a system is its economic life. Comparing the costs of owning the system to the benefits gained by retaining it determines the economic life. Once the costs outweigh the benefits, it is time to replace the system with some thing that costs less to operate or provides more benefits.

For this research all three lives of the two competing systems, C-130E/X and C-130J, will be used in determining the best replacement schedule. The remaining service life of the C-130E and the amount of life added by upgrading to the C-130X will be analyzed to determine when the replacement must be made to ensure the unit remains mission ready.

Although this study does not directly use the performance improvements to determine the best replacement schedule, the technological life of the two systems will be studied when looking at the operating and support cost differences between the airframes.

The main focus of this study centers on the economic life of the system. With identical payload capabilities, a comparison of the airframe life cycle costs will determine which one is more expensive to operate.

The next section will address fleet replacement models. By using a fleet replacement model a system manager can determine when it is time to keep an old system, upgrade the system or replace it with something new.

Fleet Replacement Models

The decision to replace a system must be based on facts and figures. It must weigh the cost of repairing the system to the cost of a replacement. As time goes on systems deteriorate and become obsolete. Therefore, at some point action must be taken to either repair or replace the system (Patton, 1988:374).

In order to accomplish this, industry uses fleet replacement models. Early studies in fleet replacement found that there were two prevalent replacement designs. The first is a uniform replacement policy where an equal number of the fleet is replaced every year. This strategy enables better long-term planning for system replacement. The second design is a staggered replacement policy where large portions of the fleet are replaced less frequently. The purpose behind this strategy is to take advantage of economies of scale during the acquisition (Jones and Zydiak, 1993:84-85).

Where the system continues to age after repair (age more quickly than a replacement system), there is the two-cycle model. This model considers an existing system with decision variables of time to replacement of existing system, K , and

subsequent time to replacement of repaired system, L . Thus the time horizon would be $K + L$ (Scarf and Christer, 1997:27). The model can be shown graphically as follows:

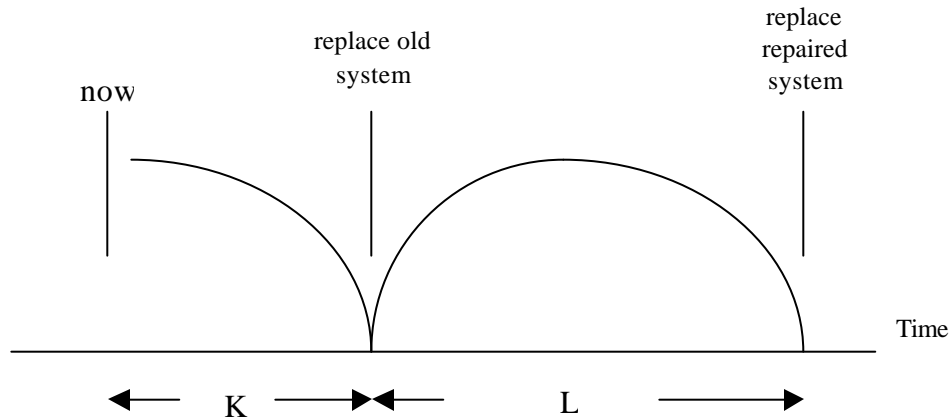

Figure 4. Two-Cycle Replacement Model

This model is solved by varying K and L to determine the least total cost.

Another type of replacement model is the parallel replacement model. This model assumes that all the systems within the fleet are economically interdependent and operate in parallel. Reasons for the economic interdependence include: economies of scale may exist when purchasing replacement systems, diseconomies of scale may exist with maintenance costs because systems purchased together tend to fail at the same time, and budgeting constraints may require that systems compete for available funds (Hartman and Lohmann, 1997:223).

This type of model differs from serial fleet replacement in that serial fleet replacement assumes all the elements of the fleet will be replaced, however, they are replaced one at a time and are examined individually.

An important issue when considering fleet replacement is whether the systems are being replaced on a one-for-one basis. Even if demand for the system does change, the

technological advances of the new system may not warrant a replacement fleet equal in number to the old fleet. As Scarf and Bouamra noted, “It may not be that demand itself is changing, but that the reliability, and hence availability, is changing with the purchase of the new equipment” (Scarf and Bouamra, 1999:40-41)

The U.S. Army recently commissioned the Utility Helicopter Fleet Modernization Analysis to determine the most cost and operationally effective strategy for fleet replacement or modernization (Prueitt, 2000:271). The analysis included multi-criteria decision analysis and total cost of ownership considerations. After considering these factors using fleet replacement models, the Army came to the decision to adopt a mixed fleet replacement. In addition to modernizing many old helicopters, the Army will also acquire new aircraft to meet mission requirements.

The fleet replacement problem can be modeled as a network flow problem, specifically, a shortest path problem. The model is represented by a series of nodes connected by arcs. For the replacement problem, the nodes represent the option for the system, retain and repair or replace. The arcs represent the valid paths that can be taken along with the associated costs of taking any particular arc. The goal of a network flow model is to determine how many items should be moved along which paths. This is accomplished by finding the least costly path through the network (Ragsdale, 2001:189-193).

Below is an example of a two-cycle replacement model using a network flow diagram. Following the diagram is an explanation of the labels.

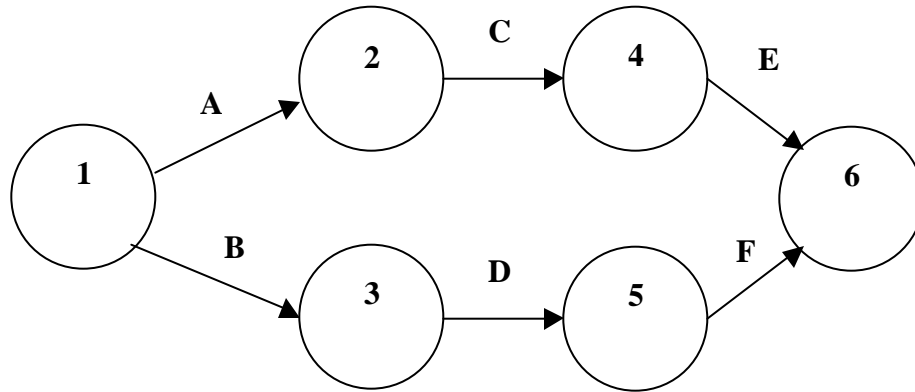

Figure 5. Two-Cycle Research Design Model

Node 1 represents the fleet as it is today. Nodes 2 and 3 are the first cycle alternatives. They could be repair, replace, or keep the system and do nothing to it. Node 4 and 5 are the second cycle alternatives. Node 6 is the fleet as it exists at the end of the time horizon.

Arcs A and B represent the cost of the decision made during the first cycle. It would include modification costs for repairs and acquisition costs for replacements. It would be zero if the system were retained with no modifications. Arcs C and D represent the operating and support costs of the system from the decision made during the first cycle to the point of decision at the second cycle. And arcs E and F are the operating and support costs required to take the decision from the second cycle decision to the end of the time horizon.

The final section of this chapter is a review of all relevant literature pertaining to life cycle costs. In order to make an informed replacement decision, the system manager must have an accurate picture of the life cycle costs for the two competing systems. If the information is inaccurate the decision could prove costly. Therefore, the decision

maker must know exactly what costs are included in the analysis and ensure that the life cycle costs for the two systems contain the same cost elements.

Life Cycle Cost Overview

In order to compare one system to another in terms of cost, all costs, not just initial acquisition costs, must be considered. Although best value is the current acquisition initiative today, with decreasing budgets and increasing acquisition and maintenance costs, the discriminator when deciding whether to replace or upgrade a system still relies on a comparison of life cycle costs (LCC). Lt Gen William Hallin notes the cost comparison between upgrading and replacing a weapon system:

Given the challenge of balancing readiness and modernization needs, today's reality dictates planned upgrades of systems and subsystems and not wholesale replacement. However, upgrades and modifications for readiness, reliability or maintainability (which could have lowered O&S costs) have not competed well against other funding requirements (Hallin, 1998:2).

In fact, in 1997 former Secretary of Defense William Cohen announced that reducing systems' life cycle costs was a necessity if the Department of Defense was going to be able to afford to modernize its weapon systems in the near future (Matthews, 1999:138).

In order to accurately define LCC it is necessary to briefly examine the acquisition process. Each phase of a system's acquisition contain different types of costs. These costs when brought together make up the system's life cycle costs.

The 5000 Model

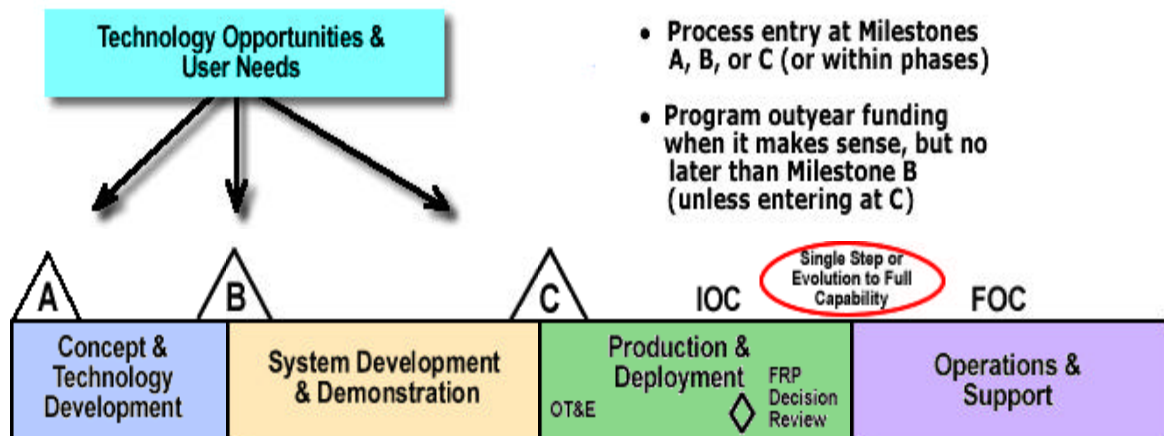

Source: Adapted from DoD Directive 5000.2 (4 January 2001).

Figure 6. DOD 5000 Acquisition Model

1. Phase A – Concept and Technology Development. The purpose of this phase is to define, and evaluate different alternatives to satisfy the mission need. During this phase, the acquisition strategy, initial cost estimates and performance parameters are defined.
2. Phase B – System Development and Demonstration. The purpose of the System Development and Demonstration phase is to develop a system, reduce program risk, ensure operational supportability, design for producibility, ensure affordability, ensure protection of Critical Program Information, and demonstrate system integration, interoperability, and utility.
3. Phase C – Production and Deployment. The purpose of the Production and Deployment phase is to achieve an operational capability that satisfies mission needs. Once maturity has been proven, the system is baselined, and a methodical and synchronized deployment plan is implemented to all applicable locations.
4. Operations and Support Phase. The objectives of this activity are the execution of a support program that meets operational support performance requirements and sustainment of systems in the most cost-effective manner for the life cycle of the system. When the system has reached the end of its useful life, it must be disposed of in an appropriate manner

Each of these acquisition phases introduces new cost elements into the system's LCC calculation. The components of a system's life cycle cost can be broken down into

four general cost elements (Messias, 1999:14-15). These cost elements are tied to the different acquisition phases.

1. Research and Development Costs. These costs are incurred during Phases A and B of the acquisition process. Costs include testing, engineering design and development and prototype fabrication.
2. Production or Procurement Costs. These costs cover activities during Phase C. The tasks associated with this cost element are facility construction, manufacturing and initial logistic support requirements.
3. Operation and Support Costs. O&S costs are incurred during the final phase and beyond. The activities that trigger this cost element are all activities for the operation and maintenance of the weapon system throughout its service life.
4. Disposal or Phase-out Costs. These costs are required to deactivate or dispose of the weapon system at the end of its service life.

A typical distribution of a weapon system's life cycle costs reveals that O&S costs are the largest component and represent more than 70% of the total acquisition program costs.

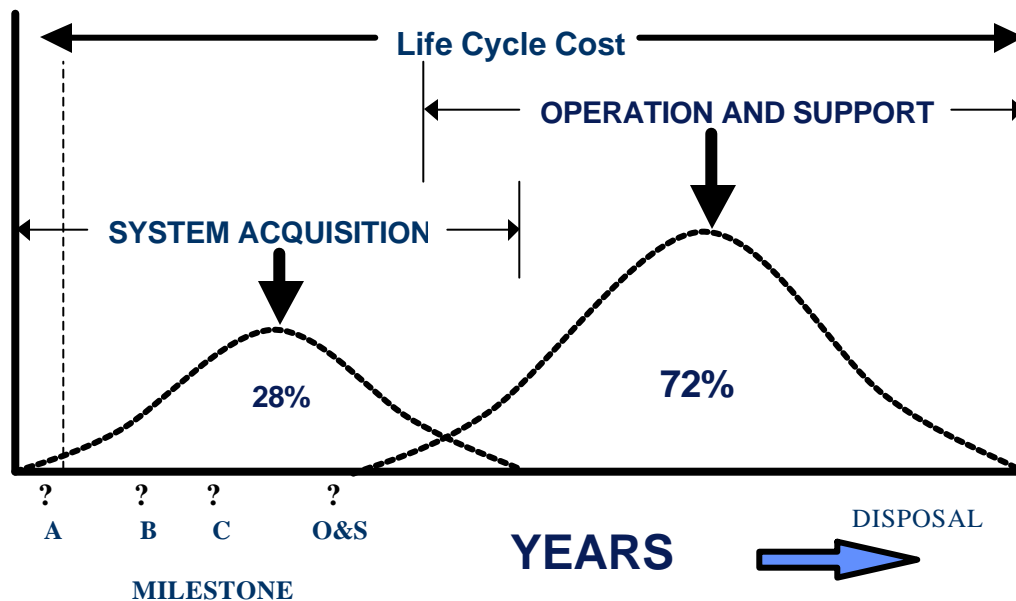

Source: Adapted from class handout, SMGT 543, AFIT. (Fall Quarter 2000).

Figure 7. Distribution of Life Cycle Costs

Using LCC when making acquisition decisions is relatively new to the Department of Defense. It wasn't until the mid 1960s that life cycle costs were even considered. In 1963 the Logistics Management Institute was commissioned by the Secretary of Defense to determine the impact of LCC in competitive procurements (Twomey, 1991:10-11).

The private sector, however, has known the advantages of using life cycle cost comparisons in procurement decisions much longer. In fact, the importance placed on it can be seen by the term used to identify it -- Strategic Cost Management (Ellram and Siferd, 1998:58).

By identifying it as a strategic process within the organization, the businesses recognize how its use can allow them to become more competitive. The company knows exactly when equipment must be upgraded or replaced by studying the different "lives" of the equipment and the associated life cycle costs.

Although the Department of Defense is a non-profit organization, the theory behind strategic cost management can be applied. The services each have specific missions that they must accomplish. At the same time they must compete for the resources to pay for the systems required to complete the mission. Therefore, by following the tenets of strategic cost management, systems managers can make informed repair/replacement decisions that take into account life cycle costs and the three "lives" associated with systems.

There are six primary reasons for using LCC analysis when managing large programs (Seldon, 1979:11-12):

1. Long-range planning and budgeting. LCC is a method of encouraging quality planning. It allows for quantitative decision making.
2. Comparison of competing programs. Life cycle cost analysis enables decision makers to compare the costs for a number of possible alternatives at once.
3. Comparison of logistics concepts. Within competing programs not only do the acquisition costs need to be compared but also the logistic support costs for each program for the ir entire service life. LCC accounts for all costs of the system/program.
4. Decisions about the replacement of aging equipment. A cost analysis separates qualitative decisions from quantitative decisions. It takes emotions out of the decision-making process and focuses on facts.
5. Control over an ongoing program. The periodic evaluation of a system's LCC provides management with a picture the program is doing and the effects of past decisions.
6. Selection among competing contractors. Just like choosing between alternative systems, LCC allows the selection of contractors. Managers want a contractor that has the resources to analyze and track the life cycle costs in order to make their own decisions.

The most significant step in conducting LCC analysis is determining the cost breakdown structure (CBS). The CBS represents the framework for defining the cost elements that constitute the life cycle costs and provides the link for cost reporting, analysis and ultimate cost control (Fabrycky and Blanchard, 1991:132).

There are four steps that must be accomplished in the CBS process when conducting an analysis of competing alternatives: 1) Identify all anticipated program activities that will generate costs over the life cycle for each of the alternatives; 2) Relate each identified activity to a specific cost category in the cost breakdown structure; 3) Develop a matrix-type worksheet to record the costs for each category by year for the

entire life cycle; and 4) Generate cost input data for each activity listed in the matrix and record the results.

When conducting a life cycle cost analysis consideration must not only be given to *which* alternative is preferred, but also to *when* the alternative becomes preferred (Blanchard, 1978:61). Breakeven analysis allows the decision maker to see at what point in time the cumulative cost of one alternative exceeds the cumulative cost of another.

An alternative that appears to be the cheapest now or even a year or two from now may not be the cheapest in three years and every year after that. With breakeven analysis the decision maker can see the cumulative life cycle costs throughout the system's service life.

Summary

This chapter reviewed the major issues affecting aging aircraft and the impact on replacement decisions. In addition, the review covered literature pertaining to fleet replacement models including how and when they should be used. Finally, the chapter concluded with a look at life cycle costs and the cost elements that are included.

The next chapter presents the methodology used to determine the best replacement schedule for Pope AFB's C-130E fleet. The chapter includes an equipment replacement model to determine the optimal schedule.

III. Methodology

Introduction

In order for Pope AFB to retain its ability to supply a mission capable fleet of C-130s, there are two feasible options available:

1. Upgrade the C-130Es to C-130Xs through the avionics modernization program and service life extension program now. This option will require replacing the C-130Xs with C-130Js but not immediately.
2. Replace the C-130Es with C-130Js immediately.

To accomplish this task, this research will conduct a life cycle cost comparison between the two options. The life cycle costs will be entered into an equipment replacement model constructed to calculate the lowest cost solution. In addition, a sensitivity analysis will be performed to analyze the effects of variation in the additional service life the C-130X provides.

Cost Analysis and Assumptions

Pope AFB is still able to meet its operational mission requirements. However, the fleet's fatigue and corrosion problems will soon cause Pope's mission capable rate to plummet. As presented earlier, Pope's C-130Es represent two-thirds of the Air Force's AWADS equipped C-130s. The decrease in mission ready aircraft will have an immediate effect on the Air Force's ability to carry out its mission. There is an urgent need to either upgrade or replace these airframes. This research model, therefore, demands that there be a decision to upgrade or replace beginning in FY03. As presented earlier, Pope's fleet will be split into three lots of 11 aircraft each. Therefore, the model will be run three times starting in FY03, FY04, and FY05.

The increased performance parameters of the C-130J are assumed to be included in the cost data provided for this research. However, this study will analyze the effects of the increased mission capable rate (MCR) of the C-130J over the C-130X. An MCR factor, f , will be established for this purpose. Below is a table identifying the MCR and MCR factor for each airframe:

Table 3. MCR Differences Between the Airframes

Parameter	C-130X	C-130J
Mission Capable Rate (MCR)	.81	.854
Relative MCR Factor, f	.95	1.00

The MCR factors are calculated as follows:

$$\text{C-130J MCR Factor} \longrightarrow (\text{C-130J MCR})/(\text{C-130J MCR}) = .854/.854 = 1.00$$

$$\text{C-130X MCR Factor} \longrightarrow (\text{C-130X MCR})/(\text{C-130J MCR}) = .81/.854 = 0.95$$

The effect of this factor is that costs for 10.5 C-130Js will be compared to 11 C-130Xs.

In order to ensure equality between the two options, the depreciated value of the C-130J will be considered. If the C-130X upgrade option is chosen then, in 2043, the end of the research time horizon, there will be between 1 to 10 years of service life remaining on the C-130J airframe. For example, if in 2003 the upgrade option is chosen and the replace option is pushed to 2008, in 2043, there will be 5 years of service life remaining on that C-130J. Therefore, 5 years of depreciation will be deducted from the cost of this option. The depreciated value will be calculated using the straight-line depreciation method on the C-130J acquisition cost.

There are a few incentives built into the C-130J contract that will be examined in this research. If between 17 and 19 aircraft are purchased in a single year, the acquisition cost is reduced by \$1 million per aircraft. For 20 through 22 aircraft, the cost is reduced by \$1.5 million. And for purchases of 23 or more aircraft, Lockheed Martin will reduce the cost by \$2 million per aircraft.

Lockheed Martin, also offers discounts if the aircraft are placed on contract in the first quarter of the fiscal year (October-December). The following table lists the amount saved on each aircraft if purchased in the first quarter of the fiscal year (Anfinson, 2002):

Table 4. C-130J Acquisition Discount

Aircraft Purchased	Discount per Aircraft
1-5	\$700,000
6	\$1,000,000
7	\$1,250,000
8	\$1,500,000
9	\$1,750,000
10	\$2,000,000
11	\$2,250,000
12 or more	\$2,500,000

There is also a penalty included in the contract. If the DoD does not procure at least 16 C-130Js per year the cost will increase by 10%. The effect of this penalty will be examined in the analysis conducted in Chapter 4.

Cost Elements Definitions

The equipment replacement model requires the input of life cycle costs for the two competing airframes. In establishing the life cycle costs needed for the model, the

cost breakdown structure is defined down to its individual elements. The model assumes a 40-year time horizon that covers the period FY2003 through FY2043.

The costs used in this analysis are in constant year 2003 dollars using the 2001 inflation indices published by the Assistant Secretary of the Air Force, Financial Management and Comptroller. The actual cost data used in the analysis was obtained from the Mobility Aircraft System Program Office located at Wright Patterson AFB, Ohio that is responsible for the acquisition of the C-130. In addition, data was gathered from Warner Robbins Air Logistics Center, Georgia, the depot responsible for all C-130 maintenance. The costs for both airframes are included in Appendices A and B.

PDM. This is the cost of periodic depot maintenance. For the C-130Es, this level of maintenance is accomplished on approximately 17% of the fleet in any one year. Therefore, for each 11 aircraft lot used in this study, the O&S costs will reflect 2 aircraft undergoing PDM each year. For the C-130J, the estimate is that only 13% will need PDM each year. This would result in 1.5 aircraft per year. Although half of an aircraft cannot be brought to the depot, 1.5 will still be used in the calculations to ensure the O&S estimates for the C-130J in this study resemble the estimates of the depot facility. In addition, the number of man-hours required for PDM increases by 1.5% per year for both airframes.

UDLM. This is also depot level maintenance, but unprogrammed depot level maintenance. These costs arise when a system on the aircraft breaks and the repair cannot be accomplished with flight line maintenance or a previously unrevealed problem is noticed during PDM. This type of maintenance has historically occurred in 8% of the C-130E fleet each year; it is estimated at 6% for the C-130J.

O&I Maintenance. O&I are the organization and installation costs required for the aircraft including flight line maintenance. The costs in this element are per aircraft per year. The man-hours required for this maintenance increases at 1.5% per year for both airframes, but the total man-hours for the C-130J are estimated to be 50% of those required for the C-130E.

Center wing costs. In order to keep the older airframes operational, corrosion and fatigue effects must be corrected. The costs in this element are to replace the center wing boxes of the C-130Es. If the option is to upgrade the C-130Es to C-130Xs in lieu of buying the C-130Js, these costs will be incurred immediately.

Fuselage SLEP. The purpose for these costs is the same as the center wing costs. As the airframes age, fuselage corrosion and fatigue cracks will need to be repaired. The difference, though, is for the time horizon chosen for this study, SLEP is not anticipated to be required for the C-130Js.

Modifications. Modifications are constantly being done to weapon systems. Although some future modifications are known for the C-130, most of the costs associated with this element are estimates based on past modification costs. Therefore, the modification costs are estimated to be the same for both airframes.

C-130J/AMP procurement. This is the biggest cost in the life cycle of the airframes. The C-130J acquisition cost and the initial C-130E/X AMP costs are included in this cost element.

Operations. These are the day-to-day costs incurred by the operational unit to fly the aircraft. Some flight line maintenance and repairs comprise the operations cost element. The cost to operate the C-130J is expected to be less than half that of the C-130E; however, the annual increase in costs for the “J” are estimated to increase by 5% as opposed to 1% for the “E.”

Other support/indirect support. These are more of the day-to-day costs associated with the aircraft such as personnel and infrastructure costs. The personnel costs include flight line maintenance personnel and aircrew at the operational units. The infrastructure costs are the hangars and maintenance sheds required at the operational base. These costs are tracked on a per aircraft per year basis. They are almost the same for each airframe and increase at 1% per year.

Fuel. This costs element estimates the fuel consumption of the aircraft based on flying hour projections. Although the C-130J is reported to be more fuel-efficient than the C-130E, the fuel costs for each are very similar. The reason for this is the fact that the C-130J is expected to fly more often and complete more missions.

Parts. Includes the costs to replace reparable or consumable items needed to maintain a required stock level for the maintenance system at the base and depot level. The cost for parts is based on per aircraft per year with the C-130J parts costs being half of the C-130E. However, the C-130E costs are increasing at only 2.5% per year while the C-130J’s are expected to rise at 3%.

Engines (depot). Engine overhauls are required after certain flying hour milestones are reached. These overhauls are conducted at the depot facility. The annual per aircraft engine costs for both airframes are similar.

Description of Model Pathways

Figure 8 is a visual depiction of the replacement model (see Appendix F). Node 0 represents the aircraft group as it is in FY03, as C-130Es. Beginning in FY03, there is a decision whether to upgrade to the C-130X (node 1) or replace with the C-130J (node 2).

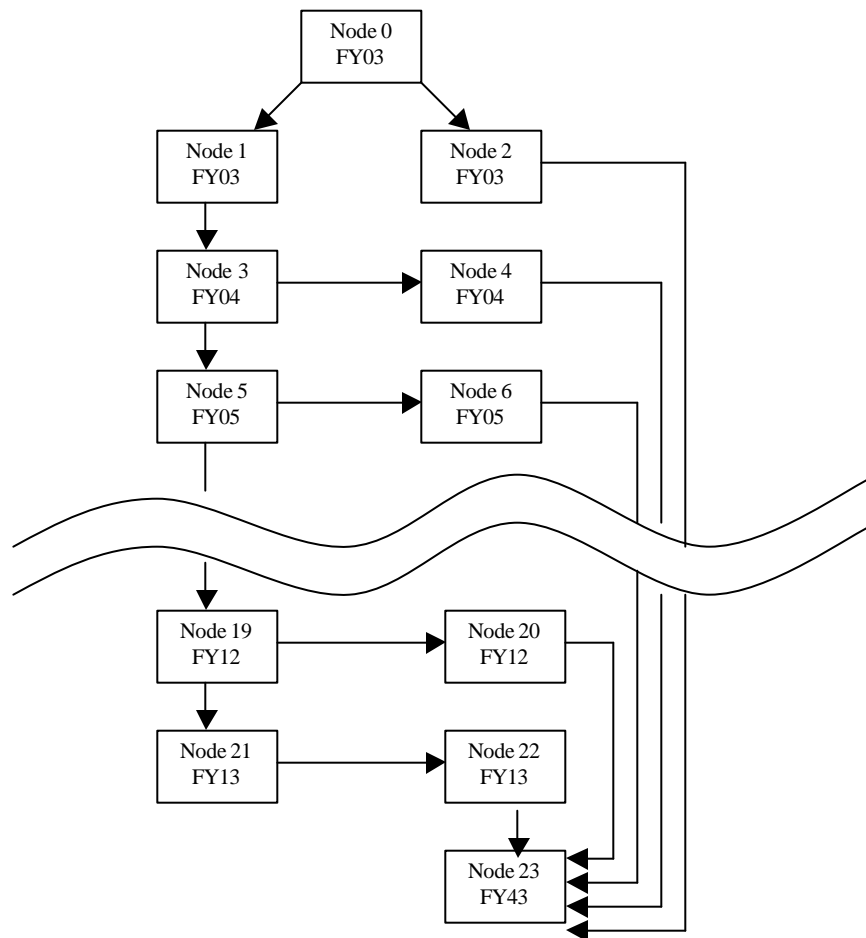

Figure 8. Research Model

If the decision is to upgrade first, the aircraft will begin to accumulate C-130X O&S costs. From this node, every year there will be a decision whether to continue with the C-130X or replace with the C-130J (nodes 3,5,7,9,11,13,15,17, & 19). Because the model assumes the C-130X option only adds a maximum of 10 years of service life to the airframe, in FY13 there is no choice -- the C-130Xs must be replaced.

Once the refurbished C-130Xs are replaced by the C-130Js, the group will continue on its appropriate C-130J O&S cost arc for the next 30 years. The O&S costs for each of these arcs will, of course, depend upon the fiscal year in which the decision was made to replace the airframes.

Description of Replacement Model Factors

The replacement model for this study is written with the Solver program with Microsoft Excel. The model takes into account the 40-year time horizon used for this research. In addition, the average added service life gained by modifying a C-130E to a C-130X is included. The added service life is estimated by program office personnel as 10 years. Also, the model assumes all costs are incurred at the beginning of each fiscal year.

Table 5. Replacement Model Results Screen

Select	Arcs		Cost	Nodes	Year	Net Flow	Supply/ Demand
	From	To					
	0	1		0	FY03	0	-1
	0	2		1	FY03	0	0
	1	3		2	FY03	0	0
	2	23		3	FY04	0	0
	3	4		4	FY04	0	0
	3	5		5	FY05	0	0
	4	23		6	FY05	0	0
	5	6		7	FY06	0	0
	5	7		8	FY06	0	0
	6	23		9	FY07	0	0
	7	8		10	FY07	0	0
	7	9		11	FY08	0	0
	8	23		12	FY08	0	0
	9	10		13	FY09	0	0
	9	11		14	FY09	0	0
	10	23		15	FY10	0	0
	11	12		16	FY10	0	0
	11	13		17	FY11	0	0
	12	23		18	FY11	0	0
	13	14		19	FY12	0	0
	13	15		20	FY12	0	0
	14	23		21	FY13	0	0
	15	16		22	FY13	0	0
	15	17		23	FY43	0	1
	16	23					
	17	18					
	17	19					
	18	23					
	19	20					
	19	21					
	20	23					
	21	22					
	22	23					
Total Cost for 11 Aircraft			\$0				

The left side of the model represents the possible paths that can be taken. The cost of each path is also listed. The right side of the model lists the nodes within the model. The nodes represent the fiscal years when decision points within the model. The model will be executed with an initial supply of -1 (defined as 11 aircraft) representing the initial need for 11 aircraft. The +1 at the end of the model signifies the constraint that

the decisions made must result in 11 aircraft available ensuring the one-for-one replacement/refurbishment throughout the model time horizon.

If the replace option is chosen immediately in FY03, there is no other decision needed. The solution path will continue to node 23. The connecting arc represents the O&S costs for the C-130J for 40 years.

At each decision point the MCR factors for the competing airframes will be used in order to account for the increased mission capable rate of the C-130J. Although the replacement will be one-for-one, the factor will help account for the large acquisition costs of the C-130J.

The goal of the model is to find the least cost solution to satisfy the requirements of 11 aircraft available from 2003 through 2043. Once the solution path is chosen, the total cost is calculated by adding up the costs of each individual arc on the solution path.

The total cost is determined by multiplying the arc value by the associated arc cost. The arc value is either a 1 or 0 depending on is the arc is within the solution path. Therefore, only the arc costs with arc values equal to 1 with be added together to get the total cost. The following table lists each arc with its associated cost.

Table 6. Arc Costs

ARC	COST	ARC	COST	ARC	COST
(0,1)	X	(7,9)	X_{OS4}	(15,16)	f^*J-7^*JD
(0,2)	J	(8,23)	J_{OS37}	(15,17)	X_{OS8}
(1,3)	X_{OS1}	(9,10)	f^*J-4^*JD	(16,23)	J_{OS33}
(2,23)	J_{OS40}	(9,11)	X_{OS5}	(17,18)	f^*J-8^*JD
(3,4)	f^*J-JD	(10,23)	J_{OS36}	(17,19)	X_{OS9}
(3,5)	X_{OS2}	(11,12)	f^*J-5^*JD	(18,23)	J_{OS32}
(4,23)	J_{OS39}	(11,13)	X_{OS6}	(19,20)	f^*J-9^*JD
(5,6)	f^*J-2^*JD	(12,23)	J_{OS35}	(19,21)	X_{OS10}
(5,7)	X_{OS3}	(13,14)	f^*J-6^*JD	(20,23)	J_{OS31}
(6,23)	J_{OS38}	(13,15)	X_{OS7}	(21,22)	f^*J-10^*JD
(7,8)	f^*J-3^*JD	(14,23)	J_{OS34}	(22,23)	J_{OS30}

where

X = Cost to upgrade C-130E to C-130X

J = C-130J acquisition cost

X_{OSt} = C-130X O&S costs for year 't'

f = C-130J MCR factor

J_{OST} = C-130J O&S costs for 'T' total years

JD = C-130J yearly depreciation cost

The total cost produced will represent the minimum cost possible through the model.

Summary

This chapter discussed the network flow model that will be used to determine the best, in terms of cost, replacement schedule for Pope AFB's C-130E fleet. Using the cost data provided, the calculated MCR rates and the airframe service lives, Chapter 4 will run the replacement model and present the results.

Chapter 5 will continue with the findings and conclusion drawn from those results. In addition, a discussion on any limitations within the study and possible recommendations for further study will be included.

IV. Analysis

Minimum Total Cost Approach

The analysis presented in this chapter will produce the minimum cost solution to the aircraft replacement problem. The model includes the life cycle costs for a single airframe from the beginning of the time horizon to the end. The total cost for each lot will be 11 times the total cost reported.

The model will initially be run three times. The first run will be for lot one from 2003 to 2043. The second lot will run from 2004 to 2044. The final run will encompass the time period 2005 to 2045. Later in this chapter additional analyses will be accomplished to study the effects of variations in the estimated costs and added service life of the C-130X.

Model Results

In order to run the model all the required costs were gathered. After using the appropriate inflation factors, the costs for Lot 1 were put in 2003 constant year dollars. The below table includes the costs (per aircraft) used in the initial model run.

Table 7. Model Input Cost Parameters

Description	Cost
C-130J Acquisition	\$65,087,539
C-130J Annual O&S	\$2,335,678
C-130J Annual O&S increase	1.46%
C-130J Depreciation per year	\$1,627,188
C-130X Upgrade (AMP+SLEP)	\$11,006,982
C-130X Annual O&S	\$3,438,365
C-130X Annual O&S increase	1.22%
MCR factor, f	0.95

Table 8. Model Results for Lot 1

Select	Arcs		Cost	Nodes	Year	Net Flow	Supply/ Demand
	From	To					
1	0	1	\$11,006,982	0	FY03	-1	-1
0	0	2	\$61,833,162	1	FY03	0	0
1	1	3	\$3,438,365	2	FY03	0	0
0	2	23	\$119,401,092	3	FY04	0	0
0	3	4	\$60,205,973	4	FY04	0	0
1	3	5	\$3,480,313	5	FY05	0	0
0	4	23	\$115,495,956	6	FY05	0	0
0	5	6	\$58,578,785	7	FY06	0	0
1	5	7	\$3,522,773	8	FY06	0	0
0	6	23	\$111,647,016	9	FY07	0	0
0	7	8	\$56,951,596	10	FY07	0	0
1	7	9	\$3,565,751	11	FY08	0	0
0	8	23	\$107,853,461	12	FY08	0	0
0	9	10	\$55,324,408	13	FY09	0	0
1	9	11	\$3,609,253	14	FY09	0	0
0	10	23	\$104,114,495	15	FY10	0	0
0	11	12	\$53,697,219	16	FY10	0	0
1	11	13	\$3,653,286	17	FY11	0	0
0	12	23	\$100,429,332	18	FY11	0	0
0	13	14	\$52,070,031	19	FY12	0	0
1	13	15	\$3,697,856	20	FY12	0	0
0	14	23	\$96,797,199	21	FY13	0	0
0	15	16	\$50,442,842	22	FY13	0	0
1	15	17	\$3,742,970	23	FY43	1	1
0	16	23	\$93,217,331				
0	17	18	\$48,815,654				
1	17	19	\$3,788,634				
0	18	23	\$89,688,978				
0	19	20	\$47,188,465				
1	19	21	\$3,834,855				
0	20	23	\$86,211,397				
1	21	22	\$45,561,277				
1	22	23	\$82,783,858				
Total Cost for 11 Aircraft			\$1,932,547,925				

The results indicate the minimum cost solution is to upgrade the first lot of C-130Es to C-130Xs immediately in 2003. The C-130Xs will be kept for 10 years, at which point they will be replaced with C-130Js. This solution represents a total cost of \$1,932,547,925 for the lot of 11 aircraft.

The results for Lots 2 and 3 produce similar results:

Table 9. Model Results for Lot 2

Select	Arcs		Cost	Nodes	Year	Net Flow	Supply/ Demand
	From	To					
1	0	1	\$11,181,506	0	FY04	-1	-1
0	0	2	\$62,935,010	1	FY04	0	0
1	1	3	\$3,497,828	2	FY04	0	0
0	2	23	\$121,466,014	3	FY05	0	0
0	3	4	\$61,278,826	4	FY05	0	0
1	3	5	\$3,540,502	5	FY06	0	0
0	4	23	\$117,493,343	6	FY06	0	0
0	5	6	\$59,622,642	7	FY07	0	0
1	5	7	\$3,583,696	8	FY07	0	0
0	6	23	\$113,577,839	9	FY08	0	0
0	7	8	\$57,966,457	10	FY08	0	0
1	7	9	\$3,627,417	11	FY09	0	0
0	8	23	\$109,718,678	12	FY09	0	0
0	9	10	\$56,310,273	13	FY10	0	0
1	9	11	\$3,671,672	14	FY10	0	0
0	10	23	\$105,915,051	15	FY11	0	0
0	11	12	\$54,654,088	16	FY11	0	0
1	11	13	\$3,716,466	17	FY12	0	0
0	12	23	\$102,166,157	18	FY12	0	0
0	13	14	\$52,997,904	19	FY13	0	0
1	13	15	\$3,761,807	20	FY13	0	0
0	14	23	\$98,471,209	21	FY14	0	0
0	15	16	\$51,341,719	22	FY14	0	0
1	15	17	\$3,807,701	23	FY44	1	1
0	16	23	\$94,829,432				
0	17	18	\$49,685,535				
1	17	19	\$3,854,155				
0	18	23	\$91,240,059				
0	19	20	\$48,029,350				
1	19	21	\$3,901,175				
0	20	23	\$87,702,337				
1	21	22	\$46,373,166				
1	22	23	\$84,215,522				
Total Cost for 11 Aircraft			\$1,966,058,734				

The least cost solution for Lot 2 is obtained by also upgrading the C-130Es to C-130Xa in FY04 followed by the replacement with the C-130J 10 years later. The total cost for the 11 aircraft in Lot 2 is \$1,966,058,734.

Table 10. Model Results for Lot 3

Select	Arcs		Cost	Nodes	Year	Net Flow	Supply/ Demand
	From	To					
1	0	1	\$11,377,239	0	FY04	-1	-1
0	0	2	\$64,008,529	1	FY04	0	0
1	1	3	\$3,559,384	2	FY04	0	0
0	2	23	\$123,603,615	3	FY05	0	0
0	3	4	\$62,324,094	4	FY05	0	0
1	3	5	\$3,602,809	5	FY06	0	0
0	4	23	\$119,561,031	6	FY06	0	0
0	5	6	\$60,639,659	7	FY07	0	0
1	5	7	\$3,646,763	8	FY07	0	0
0	6	23	\$115,576,621	9	FY08	0	0
0	7	8	\$58,955,224	10	FY08	0	0
1	7	9	\$3,691,254	11	FY09	0	0
0	8	23	\$111,649,545	12	FY09	0	0
0	9	10	\$57,270,789	13	FY10	0	0
1	9	11	\$3,736,287	14	FY10	0	0
0	10	23	\$107,778,980	15	FY11	0	0
0	11	12	\$55,586,354	16	FY11	0	0
1	11	13	\$3,781,870	17	FY12	0	0
0	12	23	\$103,964,112	18	FY12	0	0
0	13	14	\$53,901,919	19	FY13	0	0
1	13	15	\$3,828,008	20	FY13	0	0
0	14	23	\$100,204,139	21	FY14	0	0
0	15	16	\$52,217,484	22	FY14	0	0
1	15	17	\$3,874,710	23	FY44	1	1
0	16	23	\$96,498,273				
0	17	18	\$50,533,049				
1	17	19	\$3,921,982				
0	18	23	\$92,845,733				
0	19	20	\$48,848,614				
1	19	21	\$3,969,830				
0	20	23	\$89,245,753				
1	21	22	\$47,164,179				
1	22	23	\$85,697,576				
Total Cost for 11 Aircraft			\$2,000,370,787				

The least cost solution for Lot 3, like Lot 1 and 2, is obtained by first upgrading the C-130Es to C-130Xs in the initial year and then replacing them with C-130Js after 10 years. The total cost for this lot is \$2,000,370,787.

Therefore, without considering any other factors, the solution for Pope's C-130E fleet is to first upgrade each 11 aircraft lot. These C-130Xs should then be retained for 10 years and replaced with C-130Js. This overall solution represents a total cost of \$5,898,977,447. The following sections will analyze how the solution is affected by including the quantity penalty and incentives into the model.

As presented earlier, the contract between the Department of Defense and Lockheed Martin contains a cost penalty if the DoD fails to procure at least 16 C-130J aircraft per year. The DoD failed to meet this quantity in 2001 and it is not very likely they will be able to meet it in 2002. Because of this, it is probable that the costs will increase by 10% and therefore the results produced below are more realistic than those presented above.

Table 11. Lot 1 Results with Insufficient Quantity Penalty

Select	Arcs		Cost	Nodes	Year	Net Flow	Supply/ Demand
	From	To					
1	0	1	\$11,006,982	0	FY03	-1	-1
0	0	2	\$68,016,478	1	FY03	0	0
1	1	3	\$3,438,365	2	FY03	0	0
0	2	23	\$119,401,092	3	FY04	0	0
0	3	4	\$66,226,571	4	FY04	0	0
1	3	5	\$3,480,313	5	FY05	0	0
0	4	23	\$115,495,956	6	FY05	0	0
0	5	6	\$64,436,663	7	FY06	0	0
1	5	7	\$3,522,773	8	FY06	0	0
0	6	23	\$111,647,016	9	FY07	0	0
0	7	8	\$62,646,756	10	FY07	0	0
1	7	9	\$3,565,751	11	FY08	0	0
0	8	23	\$107,853,461	12	FY08	0	0
0	9	10	\$60,856,849	13	FY09	0	0
1	9	11	\$3,609,253	14	FY09	0	0
0	10	23	\$104,114,495	15	FY10	0	0
0	11	12	\$59,066,941	16	FY10	0	0
1	11	13	\$3,653,286	17	FY11	0	0
0	12	23	\$100,429,332	18	FY11	0	0
0	13	14	\$57,277,034	19	FY12	0	0
1	13	15	\$3,697,856	20	FY12	0	0
0	14	23	\$96,797,199	21	FY13	0	0
0	15	16	\$55,487,127	22	FY13	0	0
1	15	17	\$3,742,970	23	FY43	1	1
0	16	23	\$93,217,331				
0	17	18	\$53,697,219				
1	17	19	\$3,788,634				
0	18	23	\$89,688,978				
0	19	20	\$51,907,312				
1	19	21	\$3,834,855				
0	20	23	\$86,211,397				
1	21	22	\$50,117,405				
1	22	23	\$82,783,858				
Total Cost for 11 Aircraft			\$1,982,665,330				

The inclusion of this cost penalty does not change the solution path of upgrading now and replacing later. However, the overall cost for the lot has increased by \$50,117,405 to \$1,982,665,330. Running the model for Lots 2 and 3 with the included penalty produces a total solution of \$6,051,985,931, an increase of \$153,008,484.

As presented earlier, the C-130J also includes cost incentives. However, even with these incentives, the solution is still to upgrade first and replace after 10 years. The

following table shows the overall cost results produced by the model with the inclusion of the two incentives.

Table 12. Results with Early Ordering Discount

11 Aircraft Ordered in 1 st Quarter	Total Cost Upgrade/Replace	Total Cost Replace
Lot 1	\$1,914,705,495	\$1,969,362,060
Lot 2	\$1,947,898,357	\$2,003,765,042
Lot 3	\$1,981,900,638	\$2,038,666,946
Total	\$5,844,504,490	\$6,011,794,049

Because there are only 11 aircraft in each lot, the quantity discount is based on the assumption that there will be other DoD purchases of the C-130J in each fiscal year.

Table 13. Results with Quantity Discount (Upgrade/Replace)

	17-19 Aircraft	20-22 Aircraft	23+ Aircraft
Lot 1	\$1,924,617,956	\$1,920,652,972	\$1,916,687,987
Lot 2	\$1,957,987,456	\$1,953,951,816	\$1,949,916,177
Lot 3	\$1,992,161,832	\$1,988,057,354	\$1,983,952,877
Total	\$5,874,767,244	\$5,862,662,142	\$5,850,557,041

Table 14. Results with Quantity Discount (Replace)

	17-19 Aircraft	20-22 Aircraft	23+ Aircraft
Lot 1	\$1,982,814,687	\$1,977,433,636	\$1,972,052,586
Lot 2	\$2,017,457,390	\$2,011,980,451	\$2,006,503,512
Lot 3	\$2,052,592,852	\$2,047,022,490	\$2,041,452,127
Total	\$6,052,864,929	\$6,036,436,577	\$6,020,008,225

Sensitivity Analysis

Sensitivity analysis is used to determine how the solution is affected when input parameters are allowed to vary. Because this model is based on a 40-year time horizon, it is fairly certain that most of the estimated input parameters will be different than the actual costs incurred over the next 40 years. Thus, the sensitivity analysis allows decision makers to see by how much parameters need to either increase or decrease in order to change the model solution. The sensitivity analysis is accomplished on one parameter at a time while holding the other parameters constant.

Because the C-130X uses the proven airframe of the C-130E, the cost data for this option is assumed to be reliable. However, the C-130J cost data is more suspect. Therefore, the sensitivity analyses focus on fluctuations with the C-130J data.

The O&S costs for the C-130J are estimated values. The contractor predicts that the costs will be approximately 30% lower than the current C-130s. However, the actual O&S costs will not be known until the airframes begin flying true operational missions. Therefore, the first sensitivity analysis will be performed on the effects of lower C-130J O&S costs.

The following graph depicts the results of the C-130J O&S costs sensitivity analysis. As long as the C-130J O&S costs do not decrease by more than 15%, the solution remains the same – upgrade the C-130Es to C-130Xs immediately followed by replacement with C-130Js 10 years later. However, once these O&S costs decrease by more than 15% the lowest cost solution is to replace the C-130Es with C-130Js immediately.

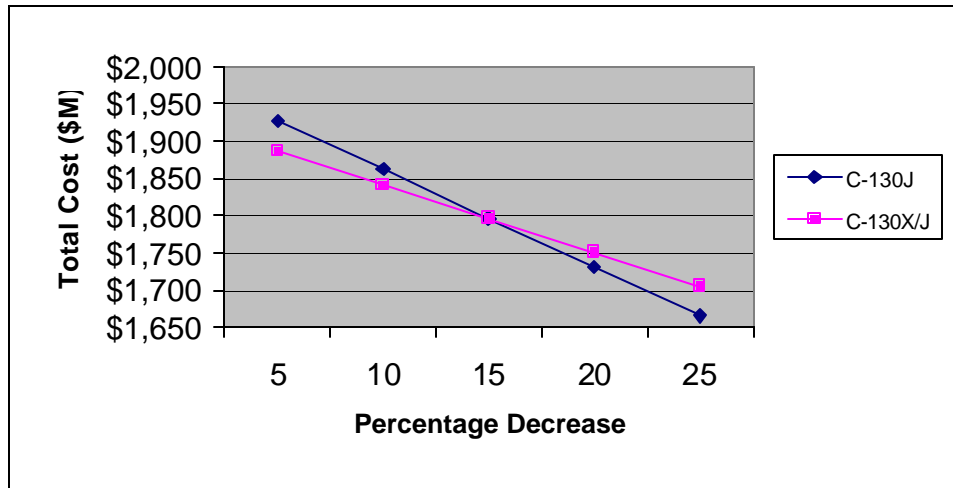

Figure 9. Effects of C-130J O&S Cost Decrease

The estimated O&S cost increase per year is 1.46% compared with that of the C-130X at 1.22% per year. Small changes in this parameter can have big effects on the overall solution. If the annual increase of C-130J O&S costs is 0.95% or less (in comparison to the estimated 1.46%) the least cost solution becomes replace the C-130Es with C-130Js without first upgrading to the C-130X.

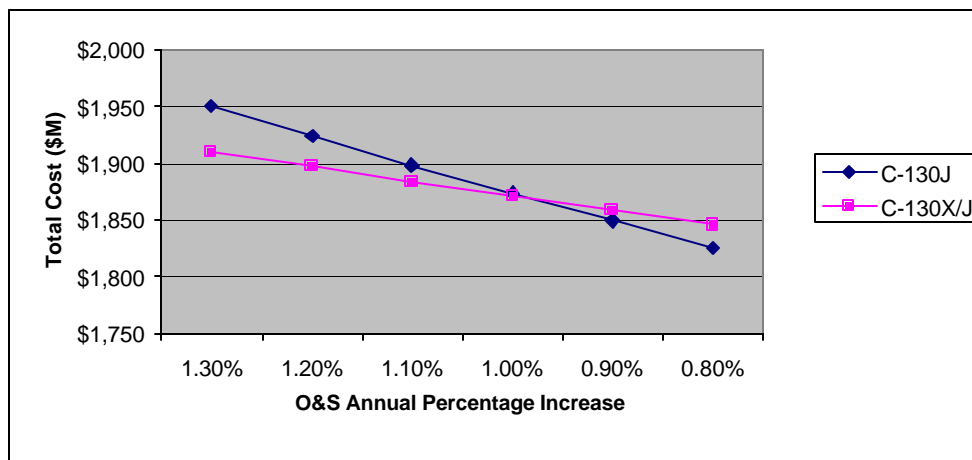

Figure 10. Effects of Variation in C-130J O&S Annual Increase

Earlier in this chapter it was discovered that even if the cost reduction incentives included in the C-130J contract are considered, the upgrade now/replace later option still represents the least cost solution. However, if Lockheed realizes the commercial and foreign sales they have anticipated, it is possible that the actual cost per aircraft may decrease by even more than stated in the contract incentives. The below chart shows the total cost consequences if the C-130J acquisition costs decrease. If the costs decrease by more than 35%, the replace now option becomes the most cost effective solution.

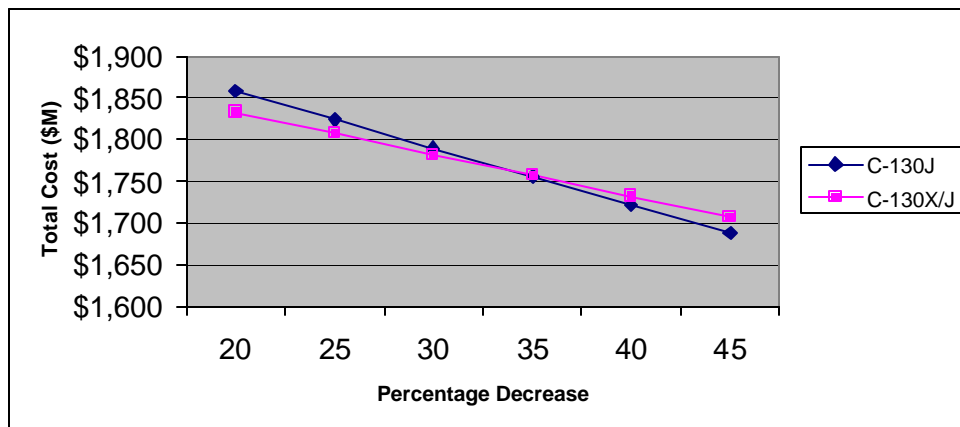

Figure 11. Effects of C-130J Acquisition Cost Decrease

Another parameter that can change is the amount of service life upgrading to the C-130X adds to the airframe. The initial estimate is 10 years. A sensitivity analysis was conducted to determine the effect of the service life variation. If the upgrade extends the airframes service life by only 6 years (or less) the upgrade now/replace later option becomes more costly than the replace now option.

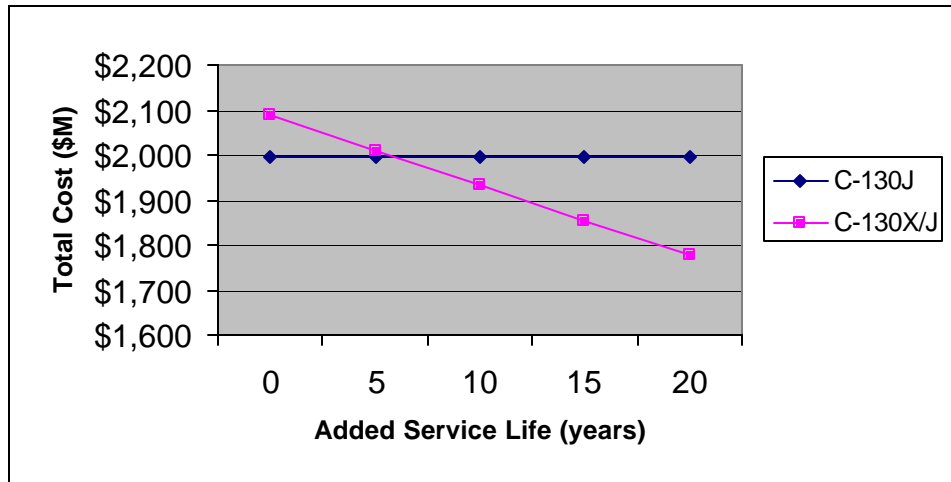

Figure 12. Effects of Increased Service Life of C-130X

Budgetary Consequences

In addition to wanting to know the low cost solution, decision makers want to know how much money will be needed and when. The low cost solution may not always be feasible if it requires a large amount of money when none is available.

For the results reached in this research this may be true. The low cost solution is to upgrade the C-130Es now and replace later. However, this requires over \$100M more in procurement funding per lot than the replace now option. The following charts show the funds required for each option.

The upgrade/replace option requires a little over \$100M for the next three years. Whereas, the replace option requires over \$700M to budgeted in each of the next three years. The upgrade/replace option will need the same \$700M budget for three years, but 10 years from now.

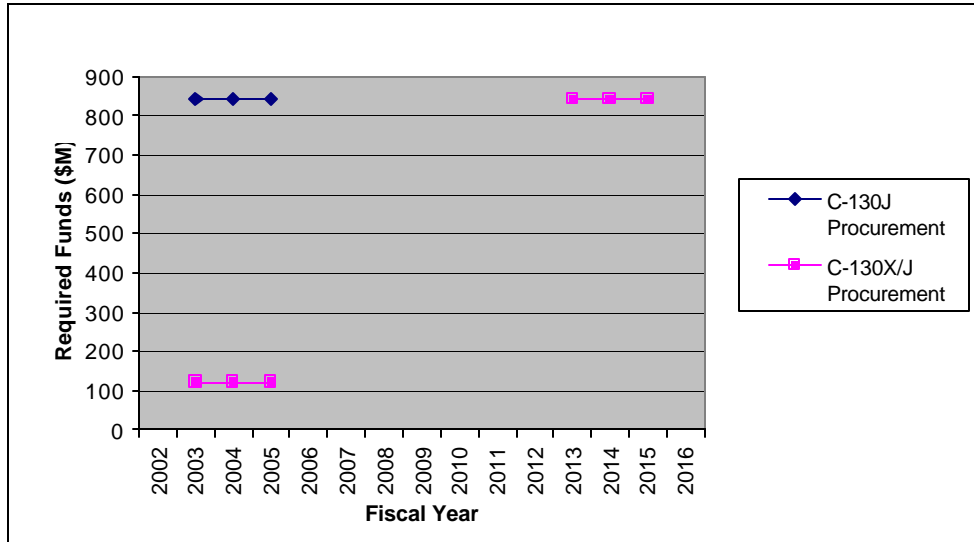

Figure 13. Procurement Funding Requirements

For the first 10 years of the upgrade first option, the O&M costs exceed that of the replace now option. Once the C-130Xs are replaced with C-130Js, though, the O&M costs fall below that of the replace now option. The lower O&M costs for the last 30 years of the time horizon is what causes the upgrade now/replace later option to be the least cost solution for the replacement model.

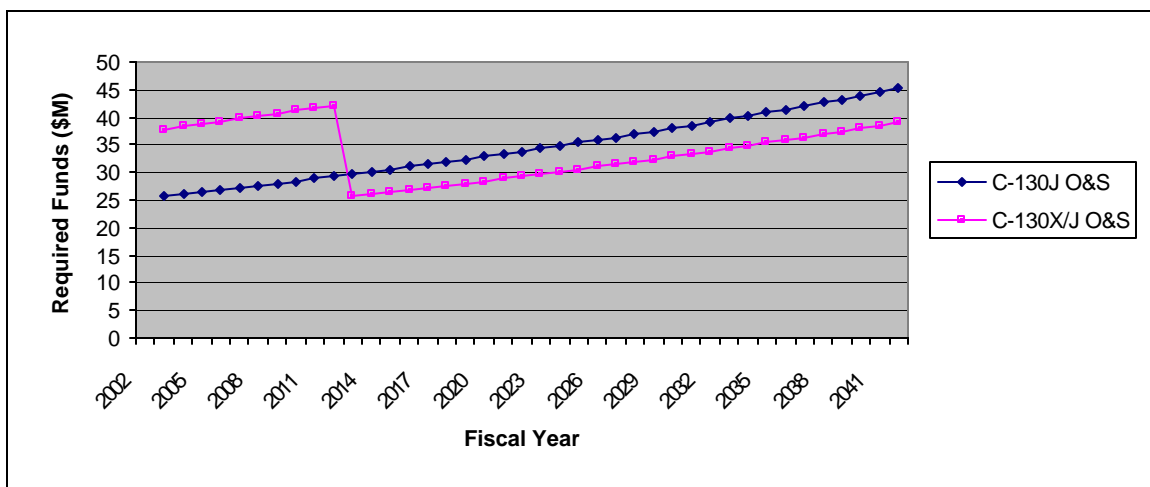

Figure 14. O&M Budget Requirements

Analysis Summary

This chapter performed a replacement analysis on the two options available for Pope's C-130E fleet. The two options are to either replace the aircraft with C-130Js now or upgrade them to C-130X now and replace later. The replacement model, using both procurement and O&S data, found the solution path based on lowest total cost.

In addition, sensitivity analyses were conducted on various parameters within the model. The purpose of this was to determine how much a parameter could vary without changing the solution path.

And finally, based on the solutions found, charts were presented reflecting the required budgets to support those solutions. The budget requirements along with the cost information can be used to determine what course of action should be taken.

The next chapter will discuss the impacts of the solution presented in this chapter. Recommendations based on these results, in addition to potential areas of further research, will also be presented.

V. Findings and Conclusions

Evaluation of Alternatives

The analysis conducted in the previous chapter focused on finding the least cost solution for Pope AFB's C-130E replacement problem. With the given input information concerning the acquisition/upgrade cost of each alternative in addition to their O&S costs, the solution returned by the model was to upgrade all of Pope's C-130Es to C-130Xs beginning in 2003 (2004 & 2005 for Lots 2 & 3, respectively). The below table summarizes the results of the analysis.

Table 15. Analysis Summary

Lots	C-130J Option	C-130X/J Option
Lot 1	\$1,993,576,787	\$1,932,547,925
Lot 2	\$2,028,411,269	\$1,966,058,734
Lot 3	\$2,063,733,577	\$2,000,370,787
Total	\$6,085,721,634	\$5,898,977,447

Sensitivity analyses were also performed to visualize the effects of input parameter variation. It was shown that the solution to upgrade now and replace later now would not change unless the C-130J O&S costs decreased by more than 15 percent or the annual O&S percentage increase was no higher than 0.95%. In addition, the C-130J acquisition costs would need to decrease by more than 35 percent to change the solution path.

The two alternatives also have significant budgetary consequences. The upgrade now/replace later option requires a little over \$100M in procurement funds for the next three years and then \$700M for three years starting in FY13. The replace now option requires the \$700M in procurement funds for the next three years starting in FY03. So although the first alternative requires more total procurement funding, the bulk of it isn't required for another 10 years, which may have an impact on the ultimate replacement decision.

Another important thing to consider for this replacement decision is the actual aircraft availability. The time required to upgrade a C-130E to a C-130X is approximately the same amount of time from order to delivery of a C-130J – 12-18 months. While the operational squadron is awaiting delivery of the C-130Js, they can continue to fly their C-130Es. But, if the decision is made to upgrade to the C-130X, the operational squadron will not have the same number of available aircraft for mission requirements while their "E" models are being upgraded.

Most Probable Scenario Solution

The sensitivity analysis revealed that the solution would change when the input parameters increased to a certain degree and everything else was held constant. However, in reality, it is possible for more than one parameter to change.

The purpose of this section is to discover what solution the model will produce given the most probable input parameters as defined by the researcher. Because the DoD has historically failed to order the quantity required to negate the penalty, it is probable

that the acquisition cost for the C-130J will increase by 10 percent. As such, the DoD will be unable to realize the quantity order discounts.

The researcher believes it is possible, and should be encouraged, that orders for all future C-130J acquisitions be placed within the first quarter of the fiscal year. This will allow the early order discount to be taken. The \$2.25M discount for ordering each lot within the first quarter will be used in this most probable scenario.

An earlier study on the C-130J used an acquisition cost that has since increased by 25 percent. Using this information, the researcher estimates that the acquisition cost for the C-130J will increase by 10 percent (in addition to the 10 percent quantity penalty).

The O&S costs for the C-130J are estimates based on the manufacturers projections. It is only after this airframe enters the U.S. Air Force inventory in substantial numbers that the true O&S costs can be determined. For this most probable scenario, the researcher is using a pessimistic 20 percent increase in C-130J O&S costs.

Based on the above assumptions, the model was run to determine the least cost solution. The table below reports the results.

Table 16. Most Probable Scenario Results

	C-130J Option	C-130X/J Option
Lot 1	\$2,368,077,418	\$2,197,064,793
Lot 2	\$2,409,447,296	\$2,235,193,470
Lot 3	\$2,451,413,662	\$2,274,196,499
Total	\$7,228,938,376	\$6,706,454,762

Using the above described variations in the input parameters, the least cost solution is to upgrade the C-130Es to C-130Xs now and then replace to the C-130J 10 years from now. This represents a savings of over \$500M for Pope's entire fleet.

Research Recommendations

This research conducted a replacement analysis between two airframes. The cost data for the C-130X is as accurate as it can be based on historical data. The cost data on the replacement aircraft, the C-130J, are estimates. Although these estimates are based on previous C-130 aircraft, with considerations given for the enormous improvements to the "J" model, they are still estimates. Better data based on actual costs would have provided a more accurate result.

Instead of comparing an upgrade/replace option to a replace option, further research could be done to find a rival system to the C-130J that could be used for the entire 40-year time horizon. This would negate having to upgrade the plane now and replace it in the future anyway. In addition, the U.S. Air Force has recently entered into talks with Boeing to lease 767s for the aerial refueling mission. Leasing the C-130Js may prove to be more costly in the long run, but it could provide new airframes now at potentially less upfront costs.

Final Comments

Although seemingly large, the acquisition cost is just one small portion of a system's total life cycle cost. In reality, the bulk, over 70 percent, of a system's costs are the after purchase, operating and support costs. These costs continue on for years after

the procurement until the time of disposal. In order to make the most cost effective acquisition decision, the total life cycle costs of the system must be considered.

As seen in the initial results of this research, although one system has lower acquisition costs than its competitor it may not be the least cost solution from a total life cycle cost perspective. This is a result of the first system having higher O&S costs than the latter system.

The Department of Defense has rightly used life cycle cost analysis for acquisition decisions for many years. This has enabled the DoD to continue with procurement and modernization programs even as budgets fall.

Appendix A. C-130J Cost Data

All costs are for a single aircraft.

PDM

Year	Cost (FY99) with 1.5% yearly increase	Cost adjusted to FY03 dollars
1	\$116,591	\$124,033
2	\$118,340	\$125,893
3	\$120,115	\$127,782
4	\$121,917	\$129,699
5	\$123,745	\$131,644
6	\$125,602	\$133,619
7	\$127,486	\$135,623
8	\$129,398	\$137,657
9	\$131,339	\$139,722
10	\$133,309	\$141,818

UDLM

Year	Cost (FY99)	Cost adjusted to FY03 dollars
1	\$9,091	\$9,671
2	\$9,091	\$9,671
3	\$9,091	\$9,671
4	\$9,091	\$9,671
5	\$9,091	\$9,671
6	\$9,091	\$9,671
7	\$9,091	\$9,671
8	\$9,091	\$9,671
9	\$9,091	\$9,671
10	\$9,091	\$9,671

Modifications

Year	Cost (FY99)	Cost adjusted to FY03 dollars
1	\$300,000	\$319,149
2	\$300,000	\$319,149
3	\$300,000	\$319,149
4	\$300,000	\$319,149
5	\$300,000	\$319,149
6	\$300,000	\$319,149
7	\$300,000	\$319,149
8	\$300,000	\$319,149
9	\$300,000	\$319,149
10	\$300,000	\$319,149

O&I Maintenance

Year	Cost (FY99) with 1.5% yearly increase	Cost adjusted to FY03 dollars
1	\$340,970	\$362,734
2	\$346,085	\$368,175
3	\$351,276	\$373,698
4	\$356,545	\$379,303
5	\$361,893	\$384,993
6	\$367,322	\$390,768
7	\$372,831	\$396,629
8	\$378,424	\$402,579
9	\$384,100	\$408,617
10	\$389,862	\$414,746

Fuel

Year	Cost (FY99)	Cost adjusted to FY03 dollars
1	\$253,333	\$274,765
2	\$253,333	\$274,765
3	\$253,333	\$274,765
4	\$253,333	\$274,765
5	\$253,333	\$274,765
6	\$253,333	\$274,765
7	\$253,333	\$274,765
8	\$253,333	\$274,765
9	\$253,333	\$274,765
10	\$253,333	\$274,765

Operations

Year	Cost (FY99) with 5% yearly increase	Cost adjusted to FY03 dollars
1	\$164,476	\$174,974
2	\$172,700	\$183,723
3	\$181,335	\$192,909
4	\$190,402	\$202,555
5	\$199,922	\$212,683
6	\$209,918	\$223,317
7	\$220,414	\$234,483
8	\$231,434	\$246,207
9	\$243,006	\$258,517
10	\$255,156	\$271,443

Parts

Year	Cost (FY99) with 3% yearly increase	Cost adjusted to FY03 dollars
1	\$316,131	\$336,310
2	\$325,615	\$346,399
3	\$335,383	\$356,791
4	\$345,445	\$367,495
5	\$355,808	\$378,519
6	\$366,482	\$389,875
7	\$377,477	\$401,571
8	\$388,801	\$413,618
9	\$400,465	\$426,027
10	\$412,479	\$438,808

Engines (Depot)

Year	Cost (FY99)	Cost adjusted to FY03 dollars
1	\$116,667	\$124,114
2	\$116,667	\$124,114
3	\$116,667	\$124,114
4	\$116,667	\$124,114
5	\$116,667	\$124,114
6	\$116,667	\$124,114
7	\$116,667	\$124,114
8	\$116,667	\$124,114
9	\$116,667	\$124,114
10	\$116,667	\$124,114

Other Support

Year	Cost (FY99) with 1% yearly increase	Cost adjusted to FY03 dollars
1	\$573,333	\$609,929
2	\$579,066	\$616,028
3	\$584,857	\$622,188
4	\$590,706	\$628,410
5	\$596,613	\$634,694
6	\$602,579	\$641,041
7	\$608,605	\$647,452
8	\$614,691	\$653,926
9	\$620,837	\$660,465
10	\$627,046	\$667,070

Year	Total operation and support costs
1	\$2,335,678
2	\$2,367,917
3	\$2,401,067
4	\$2,435,160
5	\$2,470,231
6	\$2,506,318
7	\$2,543,456
8	\$2,581,686
9	\$2,621,047
10	\$2,661,584

The O&S costs for years following 2012 are calculated based on an overall increase of 1.46% from the previous year.

C-130J Initial
Acquisition Cost

Cost (FY01)	Cost adjusted to FY03 dollars
\$63,200,000	\$65,087,539

Appendix B. C-130E/X Cost Data

All costs are for a single aircraft.

PDM

Year	Cost (FY99) with 1.5% yearly increase	Cost adjusted to FY03 dollars
1	\$218,621	\$232,575
2	\$221,900	\$236,064
3	\$225,229	\$239,605
4	\$228,607	\$243,199
5	\$232,036	\$246,847
6	\$235,517	\$250,550
7	\$239,050	\$254,308
8	\$242,635	\$258,123
9	\$246,275	\$261,995
10	\$249,969	\$265,924

UDLM

Year	Cost (FY99)	Cost adjusted to FY03 dollars
1	\$9,091	\$9,671
2	\$9,091	\$9,671
3	\$9,091	\$9,671
4	\$9,091	\$9,671
5	\$9,091	\$9,671
6	\$9,091	\$9,671
7	\$9,091	\$9,671
8	\$9,091	\$9,671
9	\$9,091	\$9,671
10	\$9,091	\$9,671

Modifications

Year	Cost (FY99)	Cost adjusted to FY03 dollars
1	\$300,000	\$319,149
2	\$300,000	\$319,149
3	\$300,000	\$319,149
4	\$300,000	\$319,149
5	\$300,000	\$319,149
6	\$300,000	\$319,149
7	\$300,000	\$319,149
8	\$300,000	\$319,149
9	\$300,000	\$319,149
10	\$300,000	\$319,149

O&I Maintenance

Year	Cost (FY99) with 1.5% yearly increase	Cost adjusted to FY03 dollars
1	\$668,640	\$711,319
2	\$678,670	\$721,989
3	\$688,850	\$732,819
4	\$699,183	\$743,811
5	\$709,670	\$754,969
6	\$720,315	\$766,293
7	\$731,120	\$777,787
8	\$742,087	\$789,454
9	\$753,218	\$801,296
10	\$764,517	\$813,316

Fuel

Year	Cost (FY99)	Cost adjusted to FY03 dollars
1	\$295,000	\$319,957
2	\$295,000	\$319,957
3	\$295,000	\$319,957
4	\$295,000	\$319,957
5	\$295,000	\$319,957
6	\$295,000	\$319,957
7	\$295,000	\$319,957
8	\$295,000	\$319,957
9	\$295,000	\$319,957
10	\$295,000	\$319,957

Operations

Year	Cost (FY99) with 1% yearly increase	Cost adjusted to FY03 dollars
1	\$416,242	\$442,811
2	\$420,404	\$447,239
3	\$424,608	\$451,711
4	\$428,855	\$456,228
5	\$433,143	\$460,791
6	\$437,475	\$465,398
7	\$441,849	\$470,052
8	\$446,268	\$474,753
9	\$450,730	\$479,500
10	\$455,238	\$484,295

Parts

Year	Cost (FY99) with 2.5% yearly increase	Cost adjusted to FY03 dollars
1	\$607,097	\$645,848
2	\$622,274	\$661,994
3	\$637,831	\$678,544
4	\$653,777	\$695,508
5	\$670,121	\$712,895
6	\$686,875	\$730,718
7	\$704,046	\$748,986
8	\$721,648	\$767,710
9	\$739,689	\$786,903
10	\$758,181	\$806,575

Engines (Depot)

Year	Cost (FY99)	Cost adjusted to FY03 dollars
1	\$115,000	\$122,340
2	\$115,000	\$122,340
3	\$115,000	\$122,340
4	\$115,000	\$122,340
5	\$115,000	\$122,340
6	\$115,000	\$122,340
7	\$115,000	\$122,340
8	\$115,000	\$122,340
9	\$115,000	\$122,340
10	\$115,000	\$122,340

Other Support

Year	Cost (FY99) with 1% yearly increase	Cost adjusted to FY03 dollars
1	\$596,613	\$634,695
2	\$602,579	\$641,042
3	\$608,605	\$647,452
4	\$614,691	\$653,927
5	\$620,838	\$660,466
6	\$627,046	\$667,070
7	\$633,317	\$673,741
8	\$639,650	\$680,479
9	\$646,046	\$687,283
10	\$652,507	\$694,156

Year	Total operation and support costs
1	\$3,438,365
2	\$3,479,445
3	\$3,521,248
4	\$3,563,790
5	\$3,607,084
6	\$3,651,147
7	\$3,695,992
8	\$3,741,636
9	\$3,788,095
10	\$3,835,384

The O&S costs for years following 2012 are calculated based on an overall increase of 1.22% increase from the previous year.

C-130X Upgrade Cost
(AMP/SLEP + Center
Wing)

Cost (FY01)	Cost adjusted to FY03 dollars
\$10,580,000	\$11,006,982

Appendix C. Data for C-130J O&S Cost Decrease Effects

C-130J O&S increase percentage	C-130X/J path cost	C-130J path cost
5	\$1,887,016,803	\$1,927,906,187
10	\$1,841,485,681	\$1,862,235,587
15	\$1,795,954,559	\$1,796,564,986
20	\$1,750,423,437	\$1,730,894,386
25	\$1,704,892,315	\$1,665,223,785

C-130J O&S <i>annual</i> percentage	C-130X/J path cost	C-130J path cost
1.3	\$1,910,508,681	\$1,950,124,541
1.2	\$1,897,071,075	\$1,923,873,488
1.1	\$1,883,886,375	\$1,898,296,678
1.0	\$1,870,949,481	\$1,873,375,460
0.9	\$1,858,255,401	\$1,849,091,714
0.8	\$1,845,799,243	\$1,825,427,833

Appendix D. Data for C-130J Acquisition Cost Increase Effects

C-130J acquisition cost decrease percentage	C-130X/J path cost	C-130J path cost
20	\$1,832,313,116	\$1,857,543,832
25	\$1,807,254,413	\$1,823,535,593
30	\$1,782,195,711	\$1,789,527,354
35	\$1,757,137,009	\$1,755,519,115
40	\$1,732,078,306	\$1,721,510,876
45	\$1,707,019,604	\$1,687,502,637

Appendix E. Data for C-130X Service Life Variation Effects

C-130X total service life	C-130X/J path cost	C-130J path cost
0	\$2,087,951,845	\$1,993,576,787
5	\$2,010,249,885	\$1,993,576,787
10	\$1,932,547,925	\$1,993,576,787
15	\$1,854,845,965	\$1,993,576,787
20	\$1,777,144,005	\$1,993,576,787

Appendix F. Network Flow Model

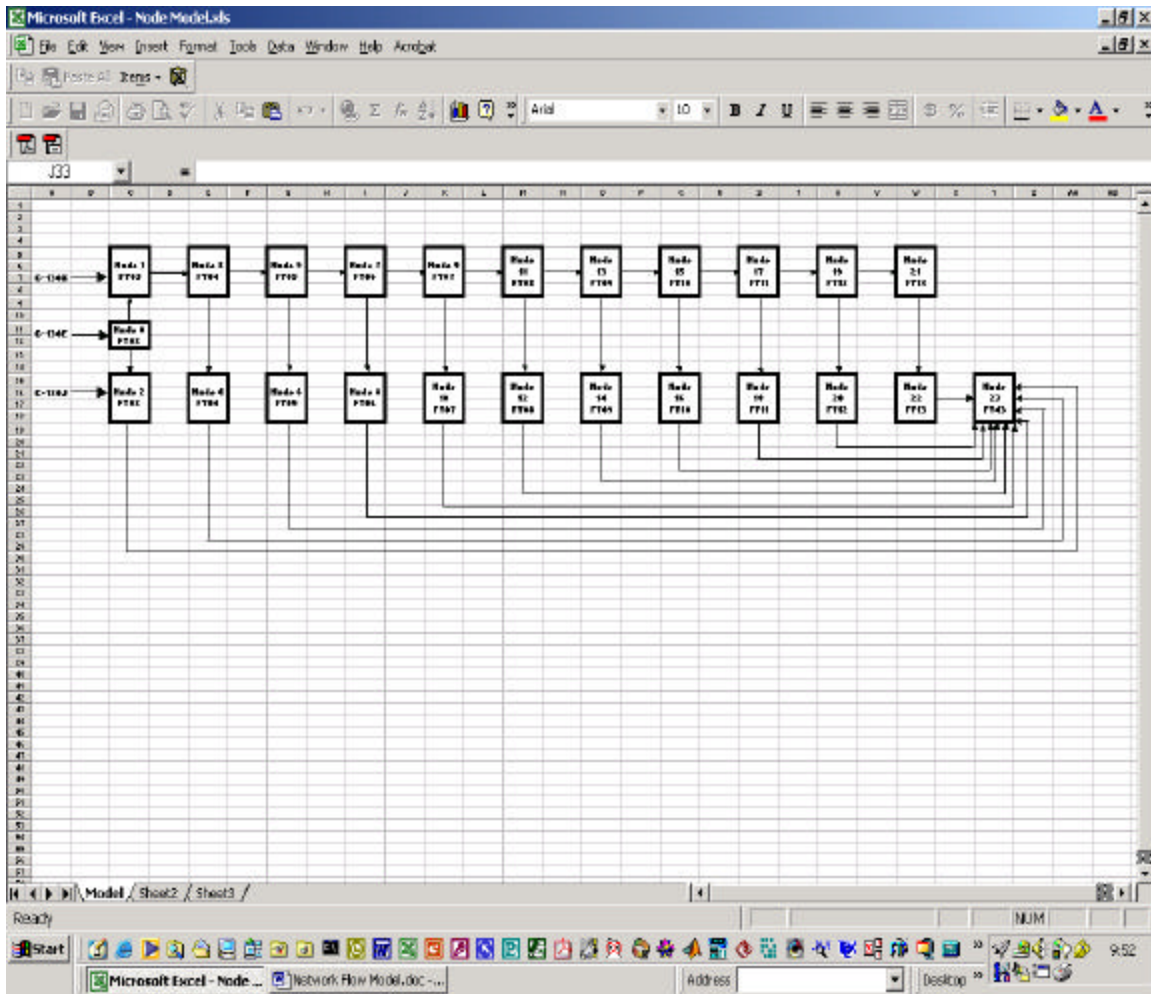

Bibliography

- Anfinson, Jeremy, Capt USAF. Program Manager, Mobility Aircraft System Program Office, Wright-Patterson AFB OH. Personal Interview. 11 January 2002.
- Ayres, Bradley. Class handout, SMGT 543, Systems Acquisition Management. School of Engineering and Management, Air Force Institute of Technology, Wright-Patterson AFB OH, Fall Quarter 2000.
- Blanchard, Benjamin S. *Design and Manage to Life Cycle Cost*. Portland OR: M/A Press, 1978.
- Defense Acquisition University. *Introduction to Defense Acquisition Management* (Fourth Edition). Fort Belvoir VA: Defense Systems Management College Press, June 1999.
- Department of Defense. *Operation of the Defense Acquisition System*. DOD Directive 5000.2. Washington: GPO, 4 January 2001.
- Department of Defense. *PPCG 1997 Compendium of Pilot Program Reports*. Washington: GPO, 1997.
- Department of the Air Force. *C-130 Broad Area Review*. Washington: HQ USAF, January 1998.
- Department of the Air Force. *Robertson Addresses A/TA Convention*. Air Force News. Washington: HQ USAF, 15 November 1999.
- Dolce, John E. "Life-Cycle Costing and Vehicle Replacement Strategies," *Commercial Carrier Journal*, 157: 92-98 (March 2000).
- Ebeling, Charles E. *An Introduction to Reliability and Maintainability Engineering*. New York: McGraw-Hill, 1997.
- Ellram, Lisa M. and Sue P. Siferd. "Total Cost of Ownership: A Key Concept in Strategic Cost Management Decisions," *Journal of Business Logistics*, 19: 55-77 (Winter 1998).
- Fabrycky, Wolter J. and Benjamin S. Blanchard. *Life-Cycle Cost and Economic Analysis*. Englewood Cliffs NJ: Prentice Hall, 1991.
- Foster, N. W. and H. D. Hunsaker. *The Effect of Aircraft Age and Flying Hours on Maintenance Costs*. AFLC 82-099. Directorate of Management Science, Air Force Logistics Command, June 1983.

- General Accounting Office. *Intratheater Aircraft: Information on the Air Force's C-130 Aircraft*. GAO/NISAD-98-108. Washington: GPO, 21 April 1998.
- Hallin, William P., Lt Gen USAF. "The Challenge of Sustaining Older Aircraft," *Air Force Journal of Logistics*, 22: 1-2 (Summer 1998).
- Hartman, Joseph C. and Jack R. Lohmann. "Multiple Options in Parallel Replacement Analysis: Buy, Lease or Rebuild," *The Engineering Economist*, 42: 223-248 (Spring 1997).
- Haven, Douglas L. *The Newest Seamless Airlifter: The C-130J-30*. MS thesis, AFIT/GMO/LAL/98J-8. School of Logistics and Acquisition Management, Air Force Institute of Technology (AU), Wright-Patterson AFB OH, June 1998.
- Institute for Defense Analyses. *C-130 Remanufacturing Study*. Alexandria VA: IDA, June 1998.
- Institute for Defense Analyses. *C-130 Remanufacturing Study: Structural Lifetime Requirements*. Alexandria VA: IDA, July 1999.
- Jones, Philip C. and James L. Zydiak. "The Fleet Design Problem," *The Engineering Economist*, 38: 83-98 (Winter 1993).
- Kabir, Zohrul. "Evaluation of Overhead/Replacement Policy for a Fleet of Buses," *Journal of Quality in Maintenance Engineering*, 2: 49-59 (Fall 1996).
- Lockheed Martin. "C-130J Hercules." Press release. n. pag. <http://www.lmasc.com/c-130j>. 29 July 2001.
- Matthews, Randy T. "Total Ownership Cost Reduction – A Secretary of Defense Imperative," *Army Logistician*, 31: 139-139 (Winter 1999).
- Messias, Julio C. *The Challenge of Maintaining or Replacing an Aging Airlift Fleet: A Cost Capability Analysis for the Brazilian Air Force Mobility System*. MS thesis, AFIT/GLM/LAL/99S-9. School of Logistics and Acquisition Management, Air Force Institute of Technology (AU), Wright-Patterson AFB OH, September 1999.
- Morris, Marion E. *C-130 The Hercules*. Novato CA: Presidio Press, 1989.
- National Research Council. *Aging of U.S. Air Force Aircraft*. Publication NMAB-488-2. Washington: National Academy Press, 1997.
- Patton Jr., Joseph D. *Maintainability and Maintenance Management* (Second Edition). Research Triangle Park NC: Instrument Society of America, 1988.

Prueitt, George C. "Case Study: U.S. Army Utility Helicopter Fleet Modernization Analysis," *The Engineering Economist*, 45: 271-289 (Summer 2000).

Ragsdale, Cliff T. *Spreadsheet Modeling and Decision Analysis* (Third Edition). Cincinnati: South-Western College Publishing, 2001.

Scarf, Philip A. and Anthony H. Christer. "Applications of Capital Replacement Models with Finite Planning Horizons," *International Journal of Technology Management*, 13: 25-36 (Winter 1997).

Scarf, Philip A. and O. Bouamra. "A Capital Equipment Replacement Model for a Fleet with Variable Size," *Journal of Quality in Maintenance Engineering*, 5: 40-49 (Winter 1999).

Seldon, M. Robert. *Life Cycle Costing: A Better Method of Government Procurement*. Boulder, CO: Westview Press, 1979.

Twomey, Mark G. *A Review of Selected USAF Life Cycle Costing Models*. MS thesis, AFIT/GLM/LSY/91S-66. School of Systems and Logistics, Air Force Institute of Technology (AU), Wright-Patterson AFB OH, September 1991.

Vita

Captain Lance R. French graduated from Alamogordo High School in Alamogordo, New Mexico. He entered undergraduate studies at New Mexico State University in Las Cruces, New Mexico where he graduated with a Bachelor of Arts degree in Economics in May 1995. He was commissioned through the Detachment 505 AFROTC at the New Mexico State University.

His first assignment was at Holloman AFB in the 49th Contracting Squadron, where he served as an operational acquisition contracting officer. While stationed at Holloman, he deployed overseas in January 1998 with the 48th Rescue Squadron. He spent three months in Kuwait as a contingency contracting officer. In August 2000, he entered the Graduate School of Engineering and Management, Air Force Institute of Technology. Upon graduation, he will be assigned to the Aeronautical Systems Center at Wright-Patterson AFB.

REPORT DOCUMENTATION PAGE				<i>Form Approved</i> OMB No. 074-0188	
<p>The public reporting burden for this collection of information is estimated to average 1 hour per response, including the time for reviewing instructions, searching existing data sources, gathering and maintaining the data needed, and completing and reviewing the collection of information. Send comments regarding this burden estimate or any other aspect of the collection of information, including suggestions for reducing this burden to Department of Defense, Washington Headquarters Services, Directorate for Information Operations and Reports (0704-0188), 1215 Jefferson Davis Highway, Suite 1204, Arlington, VA 22202-4302. Respondents should be aware that notwithstanding any other provision of law, no person shall be subject to a penalty for failing to comply with a collection of information if it does not display a currently valid OMB control number.</p> <p>PLEASE DO NOT RETURN YOUR FORM TO THE ABOVE ADDRESS.</p>					
1. REPORT DATE (DD-MM-YYYY) 03-11-2002		2. REPORT TYPE Master's Thesis		3. DATES COVERED (From - To) Oct 2000 - Mar 2002	
4. TITLE AND SUBTITLE A LIFE CYCLE COST ANALYSIS OF THE PROPOSED REPLACEMENT OF POPE AIR FORCE BASE'S C-130E USING A FLEET REPLACEMENT MODEL				5a. CONTRACT NUMBER	
				5b. GRANT NUMBER	
				5c. PROGRAM ELEMENT NUMBER	
6. AUTHOR(S) French, Lance, R., Captain, USAF				5d. PROJECT NUMBER	
				5e. TASK NUMBER	
				5f. WORK UNIT NUMBER	
7. PERFORMING ORGANIZATION NAMES(S) AND ADDRESS(S) Air Force Institute of Technology Graduate School of Engineering and Management (AFIT/EN) 2950 P Street, Building 640 WPAFB OH 45433-7765				8. PERFORMING ORGANIZATION REPORT NUMBER AFIT/GAQ/ENS/02-01	
9. SPONSORING/MONITORING AGENCY NAME(S) AND ADDRESS(ES) 43 OG/CDM Attn: Lt Col Michael Privette Pope AFB SC DSN: 424-5159 e-mail: Michael.privette@pope.af.mil				10. SPONSOR/MONITOR'S ACRONYM(S)	
				11. SPONSOR/MONITOR'S REPORT NUMBER(S)	
12. DISTRIBUTION/AVAILABILITY STATEMENT APPROVED FOR PUBLIC RELEASE; DISTRIBUTION UNLIMITED.					
13. SUPPLEMENTARY NOTES					
14. ABSTRACT The 43 rd Airlift Wing at Pope AFB, NC, possesses 33 E-model C-130 aircraft. The airplanes range in age from 30-36 years old. Current plans call for replacing Pope's aging fleet of tactical airlifters with new C-130J model planes in FY11. There are two replacement alternatives proposed in this research. The first is to call for replacing the C-130Es with C-130Js now. The second option is upgrade the C-130Es to C-130Xs and replace them in 10 years with the C-130J. The results indicate that the least cost solution is to upgrade Pope's fleet of C-130Es to C-130Xs now. However, after conducting sensitivity analyses on the input parameters, the research shows the replace now option becomes the least cost solution when any one of the following occur: the C-130J O&S costs decrease by 15 percent below the estimated values, the service life of the C-130X drops below 6 years, or the C-130J acquisition costs decrease by 35 percent. In addition, this research looks at the budgetary consequences of each option.					
15. SUBJECT TERMS Life Cycle Costs, Fleet Replacement Model, Repair and Replacement Decisions					
16. SECURITY CLASSIFICATION OF:			17. LIMITATION OF ABSTRACT	18. NUMBER OF PAGES	19a. NAME OF RESPONSIBLE PERSON
a. REPORT	b. ABSTRACT	c. THIS PAGE			William A. Cunningham, III, Ph.D. (ENS)
U	U	U	UU	80	19b. TELEPHONE NUMBER (Include area code) (937) 255-6565, ext 4283; e-mail: William.Cunningham@afit.edu